

BRASSELER
USA[®]

ENDODONTICS

Access & Initial Preparation		Obturation Materials	
Endo Solutions Pulp Vitality Spray	2	EndoSequence® Gutta Percha & Paper Points	43
True™ Dental Dam	2	Activ GP™ Sealer & Points	44
EndoSequence® Flowable Dam Material	3	Standard & Accessory Gutta Percha	45
enLite™ Curing Light	3	Finger Spreaders & Finger Pluggers	45
Access Instruments	4	Paste Fillers	45
Gates Glidden	6	EndoSequence® BC Temp™	46
Peeso Reamers	6	Root Repair Material	
Muellers	6	EndoSequence® BC RRM™	48
Nerve Broaches	6	Base/Liner & Core Build-Up Material	
ESX® Modern Access Kit	7	EndoSequence® BC Liner™	50
BioRaCe™ Access Kit	7	EndoSequence® CBM+™	52
EndoSequence® Access Kit	7	Post Systems	
Hand Files		EndoSequence® Post System	53
KontrolFlex™	8	DentFlex™ Post System	55
RazorFlex™	9	Vlock™ & Vario™ Titanium Post Systems	55
EndoSequence®	10	Power Systems	
NiTi File Systems		EndoSync™ Plus	56
EndoSequence® CM	12	EndoSync™ A.I.	57
EndoSequence® Scout Files	14	EndoSequence® 2	58
EndoSequence® VT Scout	16	EndoDrive Plus™	58
ESR™ CM	18	EndoPro 270™	59
ESR™	20	Ultrasonics	
XP-3D™	22	Forza™ V3	60
EndoSequence®	24	Ultrasonic Tips	61
ESX®	26	Hand Instruments	
ScoutRaCe™	28	Hand Instruments	65
BioRaCe™	29	Surgical Hand Instruments	
BT RaCe™	30	Endo Black™ Premium Instruments	70
RaCe™	31	Procedure Systems	
RazorFlex™	32	XP-3D™ Kits	76
EndoSequence® Apical Verifiers	33	ESR™ CM Kits	77
Irrigation & Lubricant		EndoSequence® Blend Kits	78
Triton® All-in-One Irrigation Solution	34	EndoSequence® Kits	79
Endo Solutions	36	ESX® Kits	81
Endo Solutions Irrigation Syringes	36	BioRaCe™ Kits	83
Endo Solutions Irrigation Needles	36	Ultrasonic Tip Kit	84
Endo Solutions Caddy	37	Post Kit	84
EndoSequence® Lubricant	37	Organizational Systems	
EndoSequence® Canal Clean™	37	Aluminum Bur Blocks	85
Obturation Materials		Endo Solutions Caddy	86
EndoSequence® BC Sealer™	40	EndoRing® II	86
EndoSequence® BC Points™ & Pellets™	42	EndoSwipe™	87

EndoRing® is a registered trademark of Jordco, Inc.

Endo Solutions Pulp Vitality Spray

- A quick and effective way to check cold sensitivity
- Significantly colder than ethyl chloride or ice
- For accuracy, use with micro applicators or cotton pellets
- Directional nozzle for easy placement on micro applicator or cotton pellet

Order No.
5026551U0



True™ Dental Dam

- Easily punched, stretched, and placed, supporting effective and efficient isolation set-up procedures
- Smoothly glides through contacts and tucks into the sulcus, allowing for true placement confidence
- Exceptionally durable and tear resistant, delivering the seal and tissue protection you expect and help to reduce contamination to create a clean, clear operative field
- Available in blue (latex) and purple (latex-free) to provide better color contrast with dentition

Medium Gauge



Color ID	Size (in.)	Material Type	Qty/Pk	Thickness (mm)	Order No.
Blue	5x5	Latex	52	0.23	838252-B
Blue	6x6	Latex	36	0.23	838236-B
Purple	5x5	Latex-Free	50	0.22	838200-B
Purple	6x6	Latex-Free	50	0.22	838201-B

Heavy Gauge



Color ID	Size (in.)	Material Type	Qty/Pk	Thickness (mm)	Order No.
Blue	5x5	Latex	52	0.28	838253-B
Blue	6x6	Latex	36	0.28	838237-B
Purple	5x5	Latex-Free	50	0.25	838202-B
Purple	6x6	Latex-Free	50	0.25	838203-B

EndoSequence® Flowable Dam Material

This light-cure heatless liquid dam and block-out resin can be applied to gingiva or tooth surfaces before root canal therapy, bleaching, sandblasting, or other procedures requiring intraoral protection. EndoSequence Flowable Dam Material is provided in pre-loaded syringes and is dispensed using minimum waste precision applicator tips. Upon completion of the procedure the flexible blue-colored material can quickly and easily be removed with a hand instrument.

- Flowable yet stackable consistency
- Fast light-cure and stays cool to the touch
- Flexible and tear resistant
- Stays put while still being easy to remove.



EndoSequence® Flowable Dam Material:

- 4 Flowable Dam Syringes (3ml ea.)
- 40 Tips
- 1 Safety Data Sheet (SDS)

Order No. 5028289U0

enLite™ Curing Light

- 360° Swivel Light Guide
- 420~490 nm Wavelength
- Digital Display
- Lightweight, Cordless
- Powerful, Rechargeable Lithium-Ion B
- Digital Display
- 3 Curing Modes
- 1,600 mW/cm Light Intensity



enLite™ LED Curing Light Complete Set:

- 1 enLite
- 1 Charging Base
- 1 AC Adapter
- 1 Light Guide
- 1 Anti-Glare Sleeve
- 1 Anti-Glare Cone

Order No. 5027697U0

Access Instruments

FRICITION GRIP

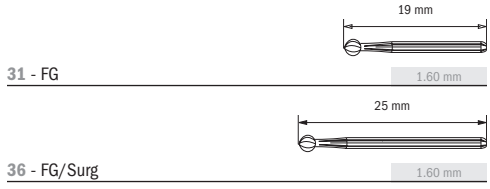

RIGHT ANGLE LATCH

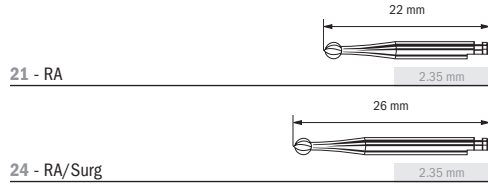

Diamonds (5/Pack)

801

Head Size ($\frac{1}{10}$ mm)	012	014	016	018	023	029
Cutting Length (mm)	-	-	-	-	-	-
Friction Grip						
● DuraCut™ (DC)	801DC	801DC	-	801DC	801DC	-
● Super-Coarse	-	-	5801	5801	5801	5801

805

Head Size ($\frac{1}{10}$ mm)	016
Cutting Length (mm)	-
Friction Grip	
● Super-Coarse	5805

835

Head Size ($\frac{1}{10}$ mm)	010	012
Cutting Length (mm)	4.0	4.0
Friction Grip		
● Super-Coarse	5835	5835

851

Head Size ($\frac{1}{10}$ mm)	012	016
Cutting Length (mm)	8.0	8.0
Friction Grip		
● Medium	851	851

856

Head Size ($\frac{1}{10}$ mm)	014	016	018	021	025
Cutting Length (mm)	8.0	8.0	8.0	8.0	8.0
Friction Grip					
● DuraCut™ (DC)	856DC	856DC	856DC	-	-
● Super-Coarse	5856	5856	5856	5856	5856

857

Head Size ($\frac{1}{10}$ mm)	014
Cutting Length (mm)	10.0
Friction Grip	
● Medium	857

15802

Head Size ($\frac{1}{10}$ mm)	012	014	016	018
Cutting Length (mm)	10.0	10.0	10.0	10.0
Friction Grip				
● DuraCut™ (DC)	15802DC	15802DC	-	15802DC
● Super-Coarse	15802	-	15802	15802

DIAMOND GRIT SIZES

- DuraCut™ (DC) = 151 micron
- Super-Coarse = 150 micron
- Medium = 100 micron

Access Instruments

Carbides (5/Pack)

SABRECUT



Us No.	557SC	330SC	331SC	245SC	1557SC	1558SC
Head Size (1/10 mm)	3.7	2.0	1.9	2.7	3.9	4.0
Cutting Length (mm)	010	008	010	008	010	012

Friction Grip

31 - FG (19 mm)	FG	FG	FG	FG	FG	FG
36 - FG/Surg (25 mm)	-	-	-	-	-	FG 36

XtremeCut.



Us No.	557MX	330MX	245MX	1557MX
Head Size (1/10 mm)	4.2	1.6	2.8	4.2
Cutting Length (mm)	010	008	008	010

Friction Grip

31 - FG (19 mm)	FG	FG	FG	FG
-----------------	----	----	----	----

H1S



Us No.	2S	4S	6S	8S
Head Size (1/10 mm)	010	014	018	023
Cutting Length (mm)	-	-	-	-

Friction Grip

31 - FG (19 mm)	FG	FG	FG	FG
36 - FG/Surg (25 mm)	FG SURG	FG SURG	FG SURG	FG SURG

Right-Angle Latch

21 - RA (22 mm)	RA	RA	RA	RA
24 - RA/Surg (26 mm)	RA 24	RA 24	RA 24	RA 24

H17

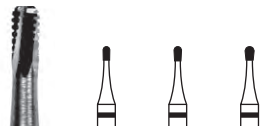

Us No.	1930	1931	1932
Head Size (1/10 mm)	009	010	012
Cutting Length (mm)	2.2	2.6	3.0

Friction Grip

31 - FG (19 mm)	FG	FG	FG
-----------------	----	----	----

H34



Us No.	-	-
Head Size (1/10 mm)	010	012
Cutting Length (mm)	2.0	2.0

Friction Grip

31 - FG (19 mm)	FG	FG
-----------------	----	----

H31B



Us No.	1957	1958
Head Size (1/10 mm)	010	012
Cutting Length (mm)	4.2	4.2

Friction Grip

31 - FG (19 mm)	FG	FG
-----------------	----	----

H269GK



Us No.	-	-
Head Size (1/10 mm)	012	016
Cutting Length (mm)	9.0	9.0

Friction Grip

31 - FG (19 mm)	FG	FG
-----------------	----	----

Compare to Endo-Z™

Endo-Z™ is a trademark of Dentsply International.

Gates Glidden

Color Coded (5/Pack)



Tip ID	Tip Size	15 mm
○ White	050	018227U0
● Yellow	070	018229U0
● Red	090	018231U0
● Blue	110	018233U0
● Green	130	018235U0
● Black	150	018237U0
Assortment	050-150	5013655U0

With Rings (6/Pack)



Tip ID	Tip Size	15 mm
1 Ring	050	5006747U0
2 Rings	070	5006748U0
3 Rings	090	5006749U0
4 Rings	110	5006750U0
5 Rings	130	5006751U0
6 Rings	150	5006752U0
Assortment	050-150	5006753U0

Short - Color Coded (5/Pack)



Tip ID	Tip Size	11 mm
○ White	050	018226U0
● Yellow	070	018228U0
● Red	090	018230U0
● Blue	110	018232U0
Assortment	050-110	018359U0

Short - With Rings (6/Pack)



Tip ID	Tip Size	11 mm
1 Ring	050	5017689U0
2 Rings	070	5017690U0
3 Rings	090	5017691U0
4 Rings	110	5017692U0
5 Rings	130	5017693U0
6 Rings	150	5017694U0
Assortment	050-150	5017695U0

Peeso Reamers

Color Coded (5/Pack)



Tip ID	Tip Size	16 mm
● Yellow	090	011698U0
● Red	110	011699U1

With Rings (6/Pack)



Tip ID	Tip Size	16 mm
1 Ring	070	5006754U0
2 Rings	090	5006755U0
3 Rings	110	5006756U0
4 Rings	130	5006757U0
5 Rings	150	5006758U0
6 Rings	170	-
Assortment	070-170	5006760U0

Muellers

Color Coded (5/Pack)



Tip ID	Tip Size	14 mm
○ White	090	5013522U0
● Yellow	100	5013523U0
● Red	120	5013524U0
● Blue	140	5013525U0
● Green	160	5013526U0
● Black	180	5013527U0
Assortment	090-160	5013521U0

Nerve Broaches

Color Coded (12/Pack)



Tip ID	Tip Size	11 mm
☆ XXXF	025	5014466U0
☆ XXF	030	5014467U0
☆ XF	035	5014468U0
☆ F	040	5014469U0
☆ M	050	5014470U0
☆ C	060	5014471U0

ESX® Modern Access Kit



Order No. 5024555U0

K0284

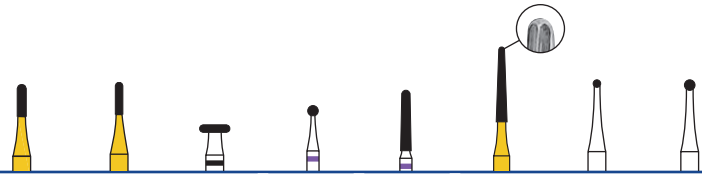

US No.	1558SC	1557SC	-	-	-	-	2	4
Figure No.	H031RS	H031RS	5909	6801DC	6856DC	H269GK	H1	H1
Head Size (1/10 mm)	012	010	040	014	014	016	010	014
Cutting Length (mm)	4.0	3.9	1.0	-	8.0	9.0	RA SURG	RA SURG
Shank Type	FG	FG	FG	FG	FG	FG	1	1
Quantity	1	1	1	1	1	1		

BioRaCe™ Access Kit



Order No. 5020020U0

K0218



US No.	-	-	-	4	2
Figure No.	6850	6801	H34L	H1	H1
Head Size (1/10 mm)	023	016	012	014	010
Cutting Length (mm)	10.0	1.6	3.5	1.4	1.0
Shank Type	FG	FG	FG	FG SURG	RA SURG
Quantity	1	1	1	1	1

EndoSequence® Access Kit



Order No. 5008861U0

K00032

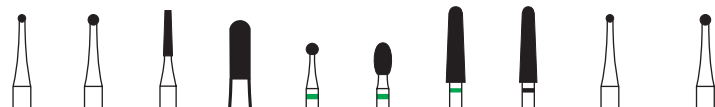

US No.	2	4	701L	-	-	-	-	-	2	4
Figure No.	H1	H1	H33L	H34L	6801	6379	6850	5850	H1	H1
Head Size (1/10 mm)	010	014	012	012	016	023	023	018	010	014
Cutting Length (mm)	1.0	1.4	6.0	3.5	1.6	4.2	10.0	10.0	1.0	1.4
Shank Type	FG	FG	FG	FG	FG	FG	FG	FG	RA SURG	RA SURG
Quantity	1	1	1	1	1	1	1	1	1	1

KontrolFlex™

- Calibrated with stops for length measurement
- Manufactured of high quality stainless steel
- Optimal combination of strength and flexibility
- Only K-Files available in 19 mm length

HAND FILES

Standard K-Files (6/Pack)



File/Tip ID	Tip Size	19 mm	21 mm	25 mm	31 mm
Pink	06	5019068U0	5011701U0	5011721U0	-
Gray	08	5019069U0	5011702U0	5011722U0	5011741U0
Purple	10	5019070U0	5011703U0	5011723U0	5011742U0
White	15	5019071U0	5011704U0	5011724U0	5011743U0
Yellow	20	-	5011705U0	5011725U0	5011744U0
Red	25	-	5011706U0	5011726U0	5011745U0
Blue	30	-	5011707U0	5011727U0	5011746U0
Green	35	-	5011708U0	5011728U0	5011747U0
Black	40	-	5011709U0	5011729U0	5011748U0
Assortment	15-40	-	5015517U0	5015518U0	5015519U0
White	45	-	5011710U0	5011730U0	5011749U0
Yellow	50	-	5011711U0	5011731U0	5011750U0
Red	55	-	5011712U0	5011732U0	5011751U0
Blue	60	-	5011713U0	5011733U0	5011752U0
Green	70	-	5011714U0	5011734U0	5011753U0
Black	80	-	5011715U0	5011735U0	5011754U0
Assortment	45-80	-	5017696U0	5017697U0	5015520U0

Stiff K-Files (6/Pack)

Compare to C-File™



File/Tip ID	Tip Size	21 mm	25 mm
Pink	06	5012644U0	5012645U0
Gray	08	5011716U0	5011736U0
Purple	10	5011717U0	5011737U0
White	15	5011718U0	5011738U0

Hedstrom Files (6/Pack)



File/Tip ID	Tip Size	21 mm	25 mm	31 mm
White	15	5011757U0	5011768U0	-
Yellow	20	5011758U0	5011769U0	5011780U0
Red	25	5011759U0	5011770U0	5011781U0
Blue	30	5011760U0	5011771U0	5011782U0
Green	35	5011761U0	5011772U0	5011783U0
Black	40	5011762U0	5011773U0	5011784U0
Assortment	15-40	5011767U0	5011778U0	5011789U0
White	45	5011763U0	5011774U0	5011785U0
Yellow	50	5011764U0	5011775U0	5011786U0
Red	55	-	5011776U0	5011787U0
Blue	60	5011766U0	5011777U0	5011788U0

K-Reamers (6/Pack)



File/Tip ID	Tip Size	21 mm	25 mm	31 mm
Gray	08	5011790U0	5011803U0	5011816U0
Purple	10	5011791U0	5011804U0	5011817U0
White	15	5011792U0	5011805U0	5011818U0
Yellow	20	-	5011806U0	5011819U0
Red	25	-	5011807U0	5011820U0
Blue	30	-	5011808U0	-
Green	35	-	5011809U0	-
Black	40	-	5011810U0	-

C-File™ is a trademark of Dentsply International.

- Slightly more flexible than KontrolFlex
- Available in larger sizes (up to 140)

Standard K-Files (6/Pack)



File/Tip ID	Tip Size	21 mm	25 mm
Gray	08	5007557U0	5007585U0
Purple	10	5007558U0	5007586U0
White	15	5007559U0	5007587U0
Assortment	08-15	5024054U0*	5024055U0*
Yellow	20	5007560U0	5007588U0
Red	25	5007561U0	5007589U0
Blue	30	5007562U0	5007590U0
Green	35	5007563U0	5007591U0
Black	40	5007564U0	5007592U0
Assortment	15-40	5018035U0	5018036U0
White	45	5007565U0	5007593U0
Assortment	20-45	-	5024056U0*
Yellow	50	5007566U0	5007594U0
Red	55	5007567U0	5007595U0
Blue	60	5007568U0	-
Green	70	5007569U0	5007597U0
Black	80	5007570U0	-
Assortment	45-80	5015648U0	5015649U0
White	90	-	5007599U0
Yellow	100	-	5007600U0
Red	110	-	5007601U0
Blue	120	-	5007602U0
Green	130	-	5007603U0
Black	140	-	5007604U0

Stiff K-Files (6/Pack)



File/Tip ID	Tip Size	21 mm	25 mm
Gray	08	5007621U0	5007624U0
Purple	10	5007622U0	5007625U0
White	15	5007623U0	5007626U0
Assortment	08-15	5024016U0*	5024053U0*

Hedstrom Files (6/Pack)



File/Tip ID	Tip Size	21 mm	25 mm
White	15	5007574U0	5007607U0
Yellow	20	5007575U0	5007608U0
Red	25	5007576U0	5007609U0
Blue	30	5007577U0	5007610U0
Green	35	-	5007611U0
Black	40	5007579U0	5007612U0
White	45	-	5007613U0
Yellow	50	-	5007614U0
Blue	60	-	5007616U0
Green	70	-	5007617U0
Black	80	-	5007618U0

*Sterile

EndoSequence®

• Available in non-ISO sizes (012 & 017)

K-Files (6/Pack)



File/Tip ID	Tip Size	21 mm	25 mm
Gray	08	5010770U0	5009085U0
Purple	10	5010771U0	5009024U0
Periwinkle	12	5010772U0	5009086U0
White	15	5010773U0	5009025U0
Beige	17	5010774U0	5009087U0
Yellow	20	5010775U0	5009026U0
Assortment	08-20	5010776U0	5009028U0

Reference Guides

NiTi File Systems Cross Reference

File Type	Brand	Company	Comparable Brasseler System
Reciprocating	WaveOne® Gold	Dentsply®	ESR™ CM
	EdgeOne Platinum™	EdgeEndo®	ESR™ CM
	EdgeOne Fire™	EdgeEndo®	ESR™ CM
	SafeSiders®	EDS®	ESR™ CM
	Tango-Endo™	EDS®	ESR™ CM
	Endo-Eze™ Genius®	Ultradent®	ESR™ CM
Non-Heat Treated Rotary	Vortex®	Dentsply®	EndoSequence®
	ProTaper®	Dentsply®	EndoSequence® CM Taper
	ProFile®	Dentsply®	EndoSequence® Scout Files
	ProFile GT®	Dentsply®	EndoSequence® Scout Files
	ProTaper Next®	Dentsply®	ESX® & EndoSequence® CM
	K3™	Kerr™/SybronEndo®	EndoSequence® & EndoSequence® Scout Files
	K3™ XF	Kerr™/SybronEndo®	EndoSequence® CM
	TF™ Twisted Files	Kerr™/SybronEndo®	EndoSequence® CM
Heat Treated Rotary	Vortex Blue®	Dentsply®	EndoSequence® CM
	ProTaper Gold®	Dentsply®	EndoSequence® CM Taper
	ProTaper Ultimate™	Dentsply®	EndoSequence® CM Taper
	TruShape®	Dentsply®	XP-3D®
	HyFlex® CM	Coltene®	EndoSequence® CM
	V-Taper™ 2	SS White®	EndoSequence® VT Scout Files
	DC Taper™	SS White®	EndoSequence® VT Scout Files
	EdgeFile® X7	EdgeEndo®	EndoSequence® Scout
	EdgeTaper Platinum™	EdgeEndo®	EndoSequence® CM Taper
	EdgeSequal™ Sapphire	EdgeEndo®	EndoSequence® CM
	EdgeTaper Encore™	EdgeEndo®	EndoSequence® CM

Speed & Torque

File System	Speed	Torque	Reciprocation Motion
EndoSequence®	500-600 RPM	1.8-2.3 Ncm	-
EndoSequence® CM	300-500 RPM	1.5-2.3 Ncm	-
EndoSequence® CM Taper	300-500 RPM	1.5-2.3 Ncm	-
EndoSequence® Scout File	300-500 RPM	0.6-2.0 Ncm	-
EndoSequence® VT Scout	300-400 RPM	4.0-5.2 Ncm	-
ESX®	500-600 RPM	1.5 Ncm	-
ESR™	300-350 RPM	-	150CCW-30CW to 170CCW-50CW
ESR™ CM	300-350 RPM	-	150CCW-30CW to 170CCW-50CW
XP-3D™	700-1000 RPM	1Ncm	-
BioRace™	500-600 RPM	1.8-2.3 Ncm	-
ScoutRace™	600 RPM (curved); 900 RPM (calcified)	-	-
BT Race™	600-800 RPM	1.5 Ncm	-
RaCe™	500-600 RPM	1.8-2.3 Ncm	-
Razorflex™	500-600 RPM	1.8-2.3 Ncm	-
EndoSequence® Apical Verifiers	500-600 RPM	.5 Ncm	-

ProFile®, ProFile GT®, ProTaper®, ProTaper Gold®, ProTaper Next®, ProTaper Ultimate™, TruShape®, Vortex®, Vortex Blue®, and WaveOne® Gold are registered trademarks of Dentsply Sirona, Inc. HyFlex® is a registered trademark of Coltene Holding AG. EdgeFile® X7, EdgeOne Fire™, EdgeOne Platinum™, EdgeSequal™ Sapphire, EdgeTaper Encore™, EdgeTaper Platinum™, and V-Taper™ are registered trademarks of Edge Endo, LLC. SafeSiders®, Tango-Endo™, and EDS® are registered trademarks of Essential Dental Systems, Inc. K3™ and SybronEndo® are registered trademarks of Kerr Corporation. DC Taper™ is a registered trademark of SS White Burs, Inc. Endo-Eze™ Genius® is a registered trademark of Ultradent Products, Inc.

THE PATENTED ENDOSEQUENCE® DESIGN

The original EndoSequence file was introduced over 15 years ago, and despite the introduction of countless competitive files, EndoSequence remains one of the most popular files available today. The patented design and quality manufacturing set the EndoSequence file apart and make it one of the most efficient cutting files on the market.

WHAT YOU LOVE ABOUT ENDOSEQUENCE®, MADE BETTER

EndoSequence CM Files are manufactured with an enhanced nitinol metallurgy and heat treatment process that allows for cutting edge fidelity and superior resistance to cyclic fatigue. EndoSequence CM provides clinicians with a more flexible option and an instrument that is significantly more resistant to separation.

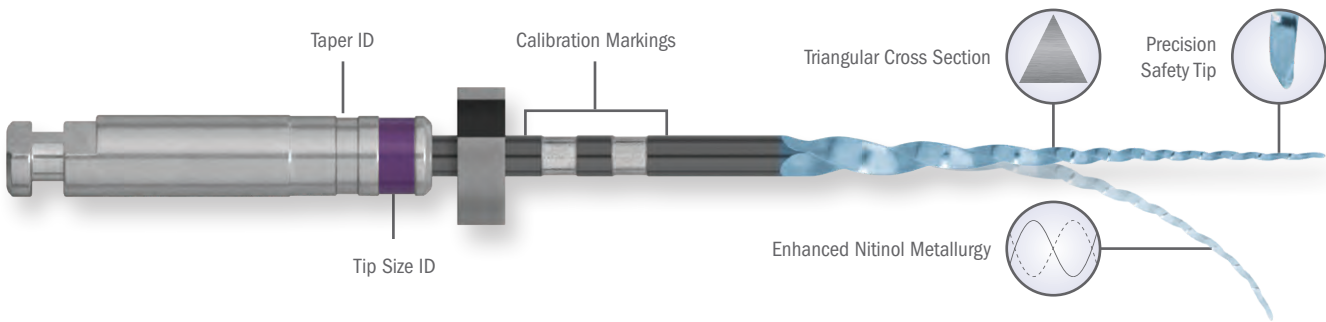

ENDOSEQUENCE® CM PRODUCT OFFERING

Individual Packs (4/Pack)



STERILE R

File/ Tip ID	Tip Size	.04 Taper			.06 Taper	
		21 mm	25 mm	31 mm	21 mm	25 mm
△ White	15	5026609U0	5026617U0	5026625U0	5026633U0	5026639U0
▲ Yellow	20	5026610U0	5026618U0	5026626U0	5026634U0	5026640U0
▲ Red	25	5026611U0	5026619U0	5026627U0	5026635U0	5026641U0
▲ Blue	30	5026612U0	5026620U0	5026628U0	5026636U0	5026642U0
▲ Green	35	5026613U0	5026621U0	5026629U0	5026637U0	5026643U0
▲ Black	40	5026614U0	5026622U0	5026630U0	5026638U0	5026644U0
△ White	45	5026615U0	5026623U0	5026631U0	-	-
▲ Yellow	50	5026616U0	5026624U0	5026632U0	-	-

File/ Tip ID	Tip Size	Variable Taper		
		16 mm	21 mm	25 mm
▲ N/A	SX/19	5027891U0	-	-
▲ Purple	S1/18	-	5027892U0	5027899U0
△ White	S2/20	-	5027893U0	5027900U0
▲ Yellow	F1/20	-	5027894U0	5027901U0
▲ Red	F2/25	-	5027895U0	5027902U0
▲ Blue	F3/30	-	5027896U0	5027903U0
Assortment	SX-F3	-	5027898U0	5027905U0
▲ Black	F4/40	-	5027897U0	5027904U0

PREMIUM BRASSLER QUALITY

EndoSequence CM files are ultra-premium NiTi files that adhere to extremely tight quality control specifications. Each step of the manufacturing process is meticulously controlled including our exclusive electropolishing process which provides the cleanest and sharpest cutting edge available on the market. EndoSequence CM files are provided in sterile blister packs to ensure that you are using the cleanest and most efficient cutting file for every procedure.

ELECTROPOLISHED SURFACE

- Eliminates surface imperfections that weaken other files
- Increases file sharpness

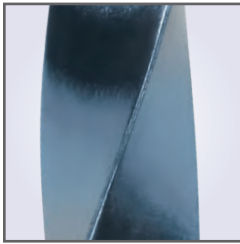

EndoSequence® CM File

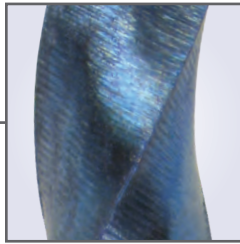

Vortex Blue® File

PRECISION TIP

- Non-active at the tip, fully active precisely at 1mm

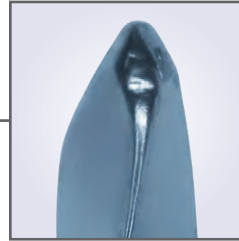

EndoSequence® CM File

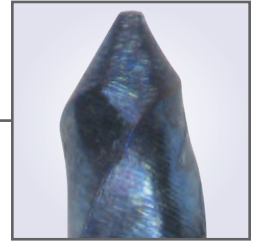

Vortex Blue® File

ENHANCED NITINOL METALLURGY

- Superior resistance to cyclic fatigue
- Allows for pre-bending for difficult access
- Deformation occurs prior to separation
- Cutting edge fidelity maximized at body temp

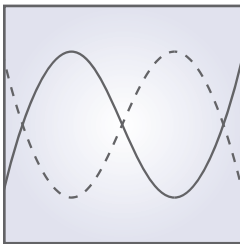

NO RADIAL LANDS

- Flexibility is maximized
- Torque is minimized
- Reduced cross section thickness
- Sharp cutting edge

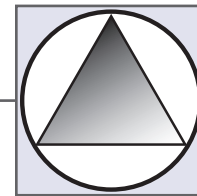

3 point engagement

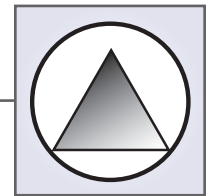

2 point engagement

PATENTED ACP (ALTERNATING CONTACT POINT™) DESIGN

- Non-landed, reduced-drag design
- Centers file within canal without radial lands
- Prevents self-threading "screw in" to canal
- Enhances debris removal
- Maximizes cutting efficiency

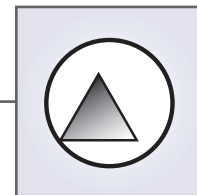
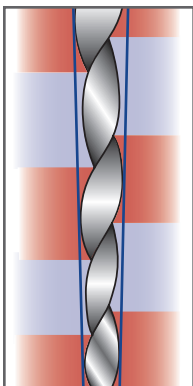

1 point engagement

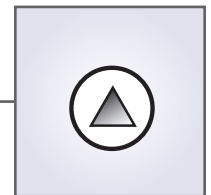

No engagement

STERILE PACKAGING

- Eliminates cross-contamination
- Improves practice efficiency



Vortex Blue® is a registered trademark of Dentsply Sirona, Inc.

EndoSequence® Scout Files

Working with multiple endodontists from different backgrounds, Brasseler has identified the most common limitations of files currently available on the market. Every feature of EndoSequence Scout Files has been designed to overcome these shortcomings.

- Shortened cutting length (12mm) reduces maximum flute diameter and facilitates better scouting of the apical third
- Exclusive NiTi allows for optimal pre-bending and flexibility
- Tighter flute structure and robust cross-section provides higher resistance to fatigue and deformation
- Precision safety tip facilitates navigation of curved and calcified canals
- Premium, uncompromised quality:
 - Compression-fit handle (allows for apex locator readings)
 - Clear calibration markings
 - Sharp cutting flutes
 - Consistent sizing
 - Precision safety tip (not blunt or pointed, which can lead to ledging)
 - Sterile blister packaging

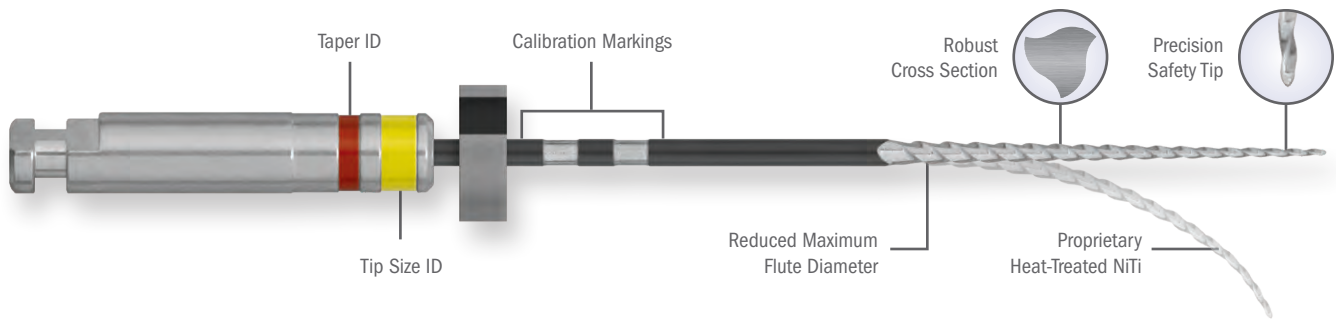

Torque Setting: .6-2Ncm
 Speed Setting: 300-500 RPM (curved); 900 RPM (calcified)

EndoSequence Scout Files are provided in sterile blister packs with four instruments per pack. We have packaged and priced these instruments with the endodontist in mind. A single-use policy is suggested thereby preventing cross contamination and maximizing patient safety and office efficiency.

ENDOSEQUENCE® SCOUT FILES TECHNIQUE

- 300-500 RPM/.6-2 Ncm Torque
- Use a light touch cleaning the flutes frequently (at least after every 3 engagements).
- Use as a stand-alone system with a crown-down or step-back technique or as a blended technique with other master files.

ENDOSEQUENCE® SCOUT FILES PRODUCT OFFERING

Individual Packs (4/Pack)

File/ Tip ID	Tip Size	.04 Taper		.06 Taper	
		21 mm	25 mm	21 mm	25 mm
△ White	15	5026685U0	5026691U0	-	-
▲ Purple	17	5026686U0	5026692U0	5027474U0	5027480U0
▲ Yellow	20	5026687U0	5026693U0	5027475U0	5027481U0
▲ Red	25	5026688U0	5026694U0	5027476U0	5027482U0
▲ Blue	30	5026689U0	5026695U0	5027477U0	5027483U0
▲ Green	35	5026690U0	5026696U0	5027478U0	5027484U0
▲ Black	40	5027104U0	5027105U0	5027479U0	5027485U0
△ White	45	5027106U0	5027107U0	5027599U0	5027600U0



STERILE R

EndoSequence® Scout Files

At a glance the below NiTi instruments look fairly similar, but closer inspection reveals significant differences. These un-retouched, high-magnification images of unused instruments highlight what can be verified clinically:

ENDOSEQUENCE® SCOUT FILES



HANDLE
Compression-fit;
apex locator
compatible

STOPPER
Sturdy; snug;
does not wobble;
stays in place

**CALIBRATION
MARKINGS**
Clearly visible

PACKAGING
Sterile blister packs

STERILE R

Magnification: 90x

CUTTING FLUTES
Clean, sharp
cutting edges

TIP
Precision safety;
guides around curves

COMPETITOR A **COMPETITOR B**

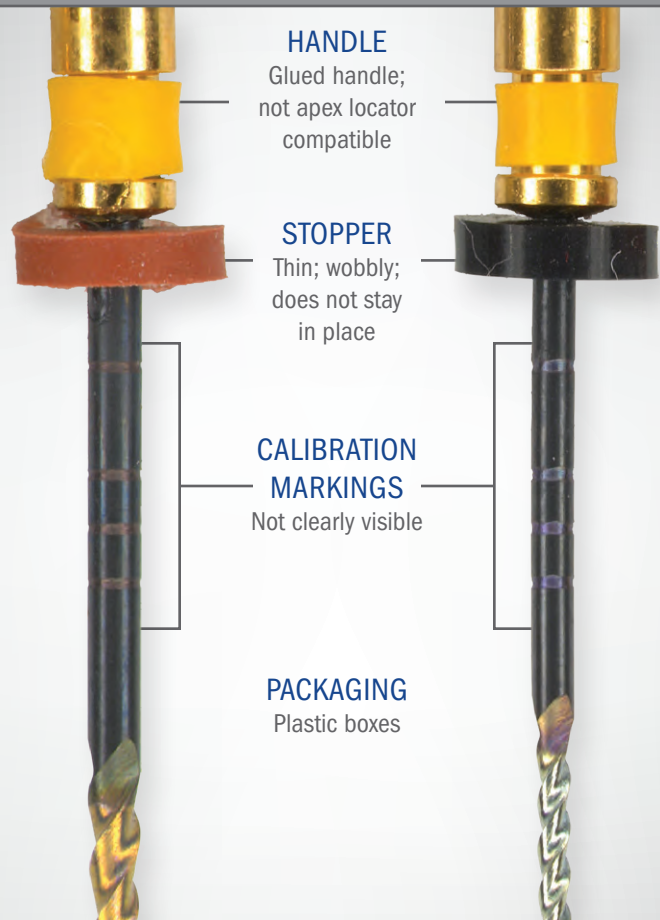

HANDLE
Glued handle;
not apex locator
compatible

STOPPER
Thin; wobbly;
does not stay
in place

**CALIBRATION
MARKINGS**
Not clearly visible

PACKAGING
Plastic boxes

Magnification: 90x

CUTTING FLUTES
Machine grinding
evident

TIP
Blunt (left) or
pointed (right)

EndoSequence® VT Scout Files

EndoSequence VT Scout Files feature a proprietary variable tapered design that allows for deep apical shaping while preserving coronal tooth structure. This design is comparable to the V Taper™ 2 file, previously sold by SS White®. Minor design upgrades include a short 16mm compression-fit nickel handle and a more robust stopper. These heat-treated NiTi files are extremely resistant to cyclic fatigue and are preferred by clinicians that embrace a minimally invasive shaping philosophy.

NiTi FILE SYSTEMS

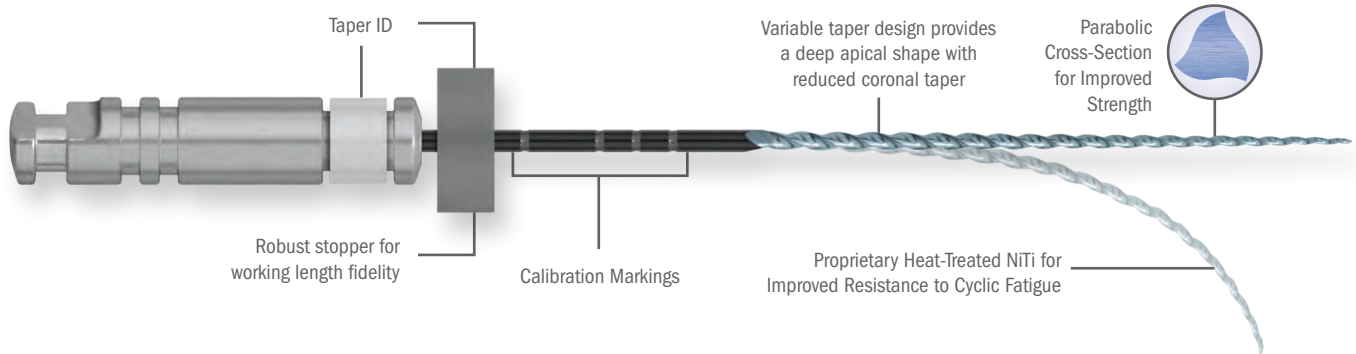

There has been a paradigm shift in endodontics in which canal preparations have been transitioning from larger flared shapes to less invasive shapes, especially in the coronal third. This change has coincided with the introduction of advanced irrigation systems and non-shrinking, bonded bioceramic sealer, such as EndoSequence BC Sealer™. EndoSequence VT Scout files feature a maximum flute diameter (MFD) which is extremely conservative. However, the tip portion is designed to provide an optimal “deep apical shape”, which helps to facilitate proper irrigation and obturation.

Cross-Section	Tip Size	D5	MFD
	0.13	0.28	0.48
	0.14	0.29	0.56
	0.17	0.35	0.55
	0.2	0.47	0.7
	0.25	0.52	0.75

Max. Diameter of Other Popular NiTi Systems

ProTaper Ultimate™	MFD
Slider	.99
Shaper	1.0

Vortex Blue™	MFD
20/.04	0.84
25/.04	0.89

ENDOSEQUENCE® VT SCOUT FILES PRODUCT OFFERING

Individual Packs (4/Pack)

File/Tip ID		Tip Size	17 mm Orifice Shaper	21 mm	25 mm	
Band	Stopper					
	Purple	Green	13	-	5028563U0	5028568U0
	White	Yellow	14	-	5028564U0	5028569U0
	White	Gray	17	-	5028565U0	5028570U0
	Yellow	Black	20	-	5028566U0	5028571U0
	Red	Black	25	-	5028567U0	5028572U0
	Clear	N/A	25	5028573U0	-	-
Assortment (5/Pack)			13-25	-	5029121U0	5029122U0

V-Taper™ is a trademark of EdgeEndo®. SS White® is a registered trademark of SS White Dental, Inc. ProTaper Ultimate™ and Vortex Blue® are trademarks of Dentsply Sirona, Inc. GentleWave® is a registered trademark of Sonendo, Inc.

CASE STUDIES

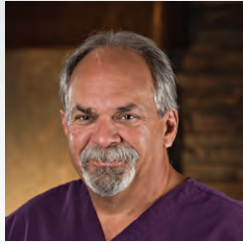

Dr. Tom McClammy D.M.D., M.S.
North Scottsdale
Endodontics & Implantology
Scottsdale, AZ

“ *The EndoSequence VT Scout Files provide a conservative coronal preparation with the deep apical shape that I prefer. The files allow me to confidently navigate extremely tight and curved canals with ease.* ”



Case shaped with VT Scout Files followed by GentleWave® and obturated with BC Sealer HiFlow



Adam Davis, DDS
Cumberland Endodontics

“ *At Cumberland Endodontics, dentin preservation and efficiency are always top of mind. These files allow me to predictably treat difficult cases, preserve dentin, and provide the best outcome for our patients.* ”

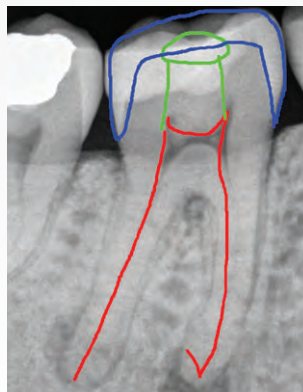

Pre-op radiograph/
treatment planning



Canals shaped conservatively with VT Scout 14/03, 17/04 and finished with EndoSequence® CM 20/04

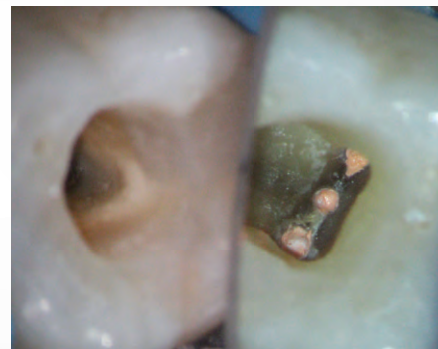

Case obturated with EndoSequence® BC Sealer HiFlow™ and MF gutta percha

ESR™ CM EndoSequence® Controlled Memory Reciprocating Files

ESR utilizes the latest NiTi technology to provide clinicians with superior safety, efficiency and performance. ESR files are also designed to preserve more coronal tooth structure compared to WaveOne® Gold.

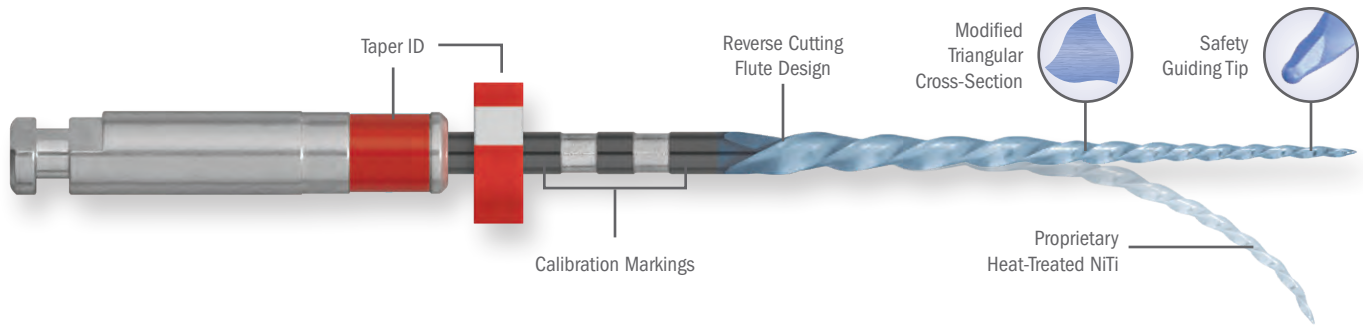

- Reverse-cutting flute design: cuts on the counter-clockwise motion
- Compatible with EndoSync™ Plus, ProMark®, e3® and NLZ™ E electric motors
- Available in #15 (Scout), #25, #30, #40 and #50
- Heat treated NiTi allows for pre-bending
- Constant taper design
- Sterile blister packs of three instruments

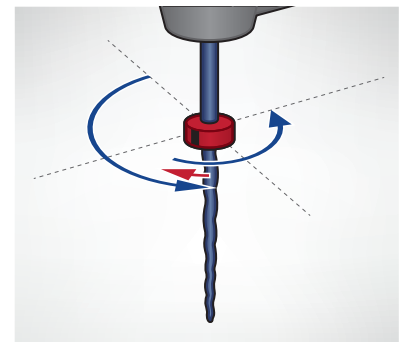

ESR™ CM VS. WAVEONE® GOLD

- ESR CM features a similar but more flexible flute design*
*63% of evaluators noted that ESR CM is more flexible than WaveOne® Gold in an internal clinical survey.
- ESR CM features a size #30 which is less invasive than the WaveOne® Gold primary file
- ESR CM can be autoclaved if sterility is compromised
- ESR CM features a novel safety tip optimized for reciprocation

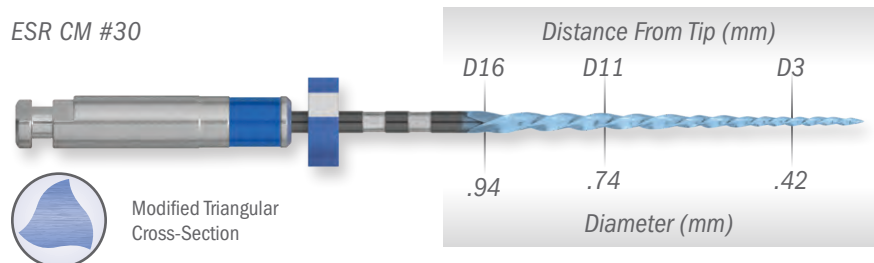
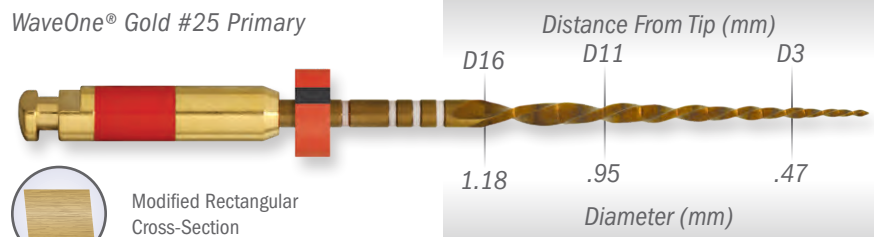

NLZ™ is a trademark of Nakanishi, Inc.
WaveOne®, ProMark® and e3® are registered trademarks of Dentsply Sirona, Inc.

ESR™ CM EndoSequence® Controlled Memory Reciprocating Files

500 rpm/.2 Ncm
Motion: Memory #3 (CCW 180°/CW 60°)

ESR™ CM TECHNIQUE*

1. After straight line access, determine working length (WL) with a size #10 K-file. In extremely tight canals consider establishing glidepath to WL with the ESR CM #15C Scout file.
2. Use the ESR CM #25 primary/gauging file to estimate the canal size by engaging in three light strokes.
 - a. If the file reaches the apex easily the canal is “Basic” (larger) and you should finish with the Large ESR CM #40 or Extra-Large ESR CM #50 file.
 - b. If the ESR CM #25 does not reach the apex after two series of three light strokes the canal is “Advanced” (tighter) and you need to use a #15 K-file or the ESR CM #15C Scout file to reestablish a safe glidepath to WL. Next, finish with an ESR CM #30 (which actually has a smaller max diameter than the #25). For extremely tight canals consider finishing with the Small ESR CM #20.
3. Obturate with BC Sealer™ and the matching BC Points™ for the last file used to reach WL.

*Summarized technique as taught by Real World Endo®. See IFU for complete instructions.

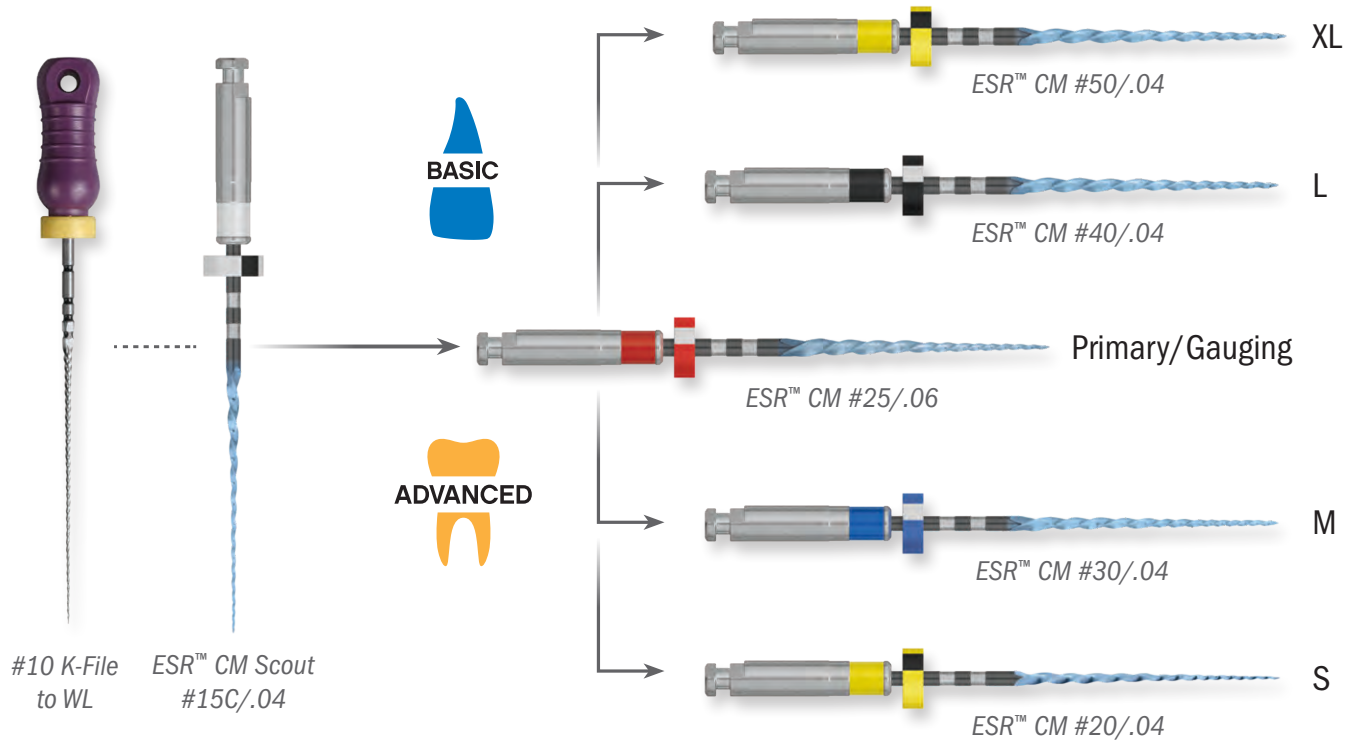

ESR™ CM PRODUCT OFFERING

Individual Packs (3/Pack)

ESR CM files are provided in sterile blister packs for optimal convenience and safety. If sterility is compromised prior to treatment the files can be sterilized without any loss of functionality or performance.

File/Tip ID	Tip Size	21 mm	25 mm	31 mm
△ White	15C	5029334U0	5029335U0	5029336U0
▲ Yellow	20	5029126U0	5029127U0	5029128U0
▲ Red	25	5028078U0	5028086U0	5028094U0
▲ Blue	30	5028079U0	5028087U0	5028095U0
▲ Black	40	5028081U0	5028089U0	5028097U0
▲ Yellow	50	5028082U0	5028090U0	5028098U0



ESR™ EndoSequence® Reciprocating Files

ESR utilizes the latest NiTi technology to provide clinicians with superior safety, efficiency and performance. ESR files are also designed to preserve more coronal tooth structure compared to WaveOne® Gold.

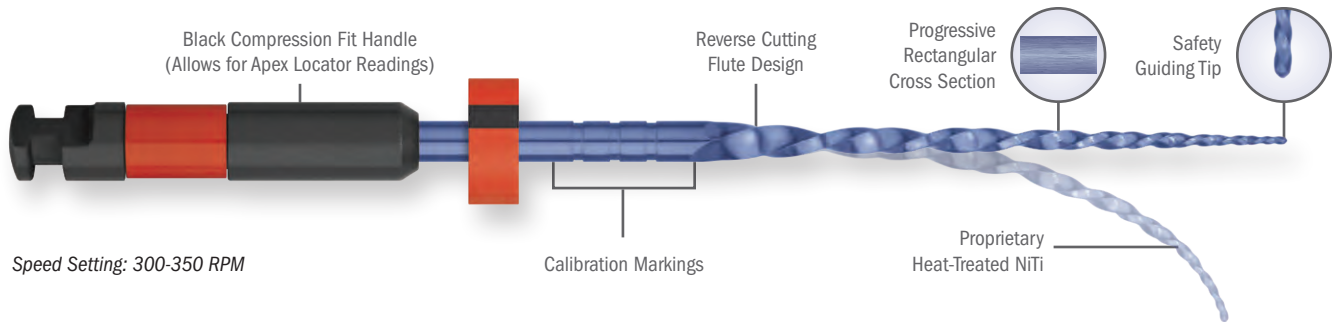

ESR™ VS. WAVEONE® GOLD

Similarities

- Reverse-cutting flute design: cuts on the counter-clockwise motion (Fig. 1)
- Compatible with EndoSync™ Plus, ProMark®, e3® and NLZ™ E electric motors (reciprocating range of motion: 150°CCW/30°CW - 170°CCW/50°CW)
- Available in #20 (small), #25 (primary), #35 (medium), #45 (large) and #17 (scouting file)
- Heat treated NiTi allows for pre-bending
- Progressive taper design (Fig. 2)
- Sterile blister packs of three instruments

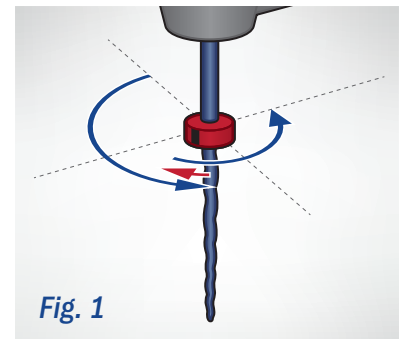

Fig. 1

STERILE R

Fig. 2



ESR Advantages

- ESR features a similar but more conservative design (Fig. 3 & 4)
- Smoother cutting/less chatter
- ESR can be autoclaved if sterility is compromised
- ESR is more cost effective

Fig. 3

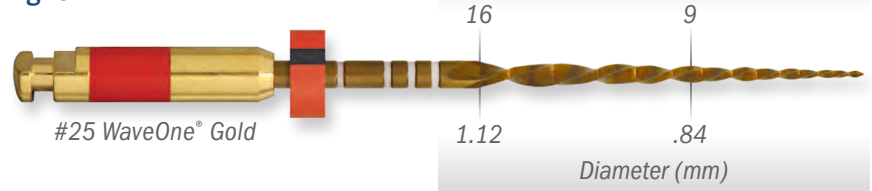
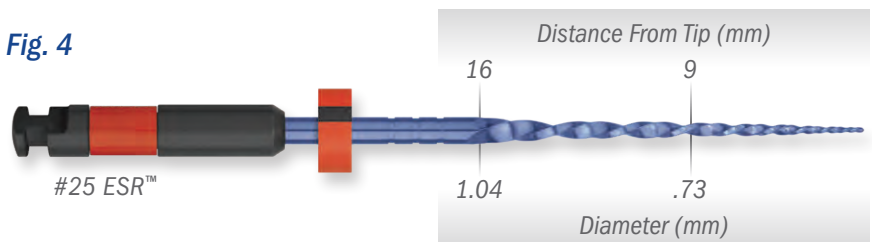

Fig. 4



NLZ™ is a trademark of Nakanishi, Inc.

WaveOne®, ProMark® and e3® are registered trademarks of Dentsply Sirona, Inc.

ESR™ EndoSequence® Reciprocating Files

ESR™ TECHNIQUE

1. Establish Working Length (WL) with a #10 K-File.
2. Start with ESR #25 Primary File. Use two series of Rhythm Motions.
Rhythm Motion = three light strokes to engagement, remove file and clean flutes of debris, reirrigate
3. If Primary File (#25) reaches WL easily, finish with a larger file (#35 or #45). If not, finish with a smaller file (#20).
4. Obturate with matching ESR™ BC Points™ and EndoSequence® BC Sealer™.

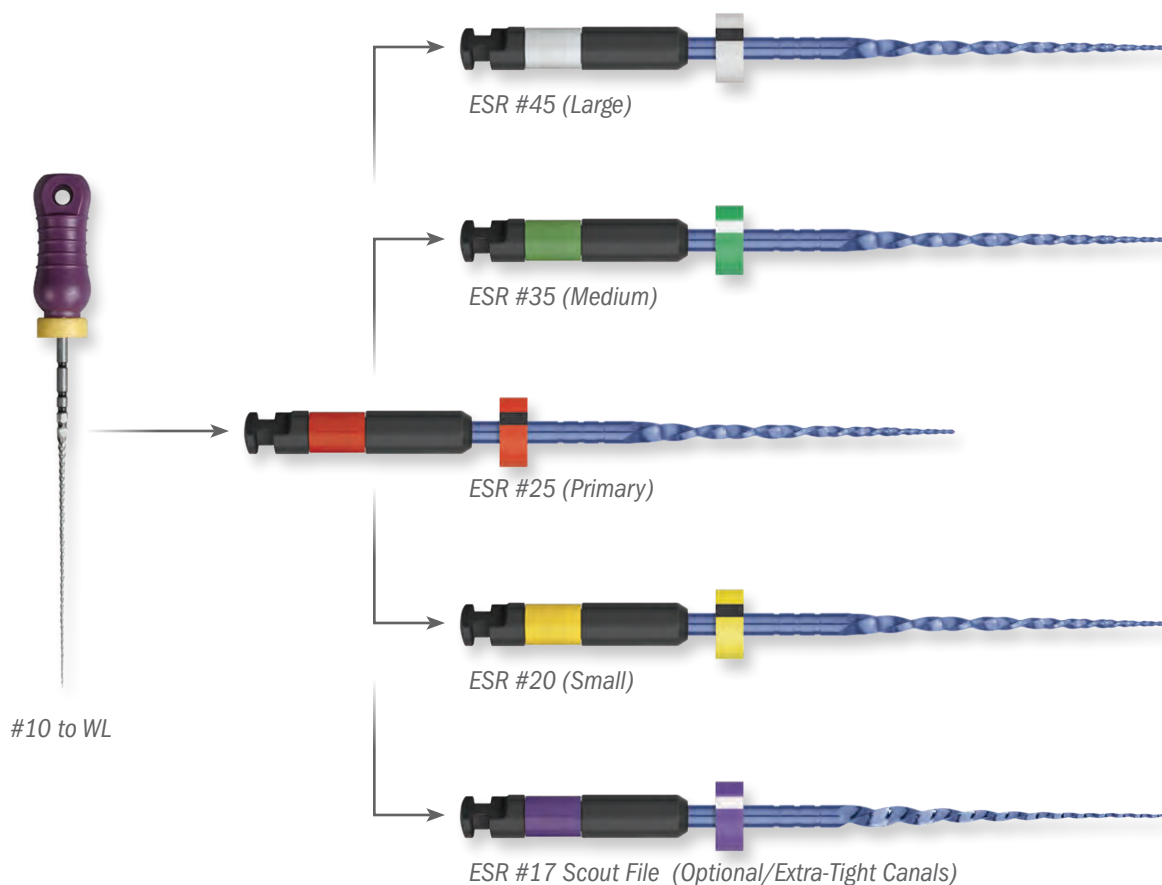

ESR™ PRODUCT OFFERING

Individual Packs (3/Pack)

ESR files are provided in sterile blister packs for optimal convenience and safety. If sterility is compromised prior to treatment the files can be sterilized without any loss of functionality or performance.

File/Tip ID	Tip Size	21 mm	25 mm	31 mm
▲ Purple	17	5026662U0	5026667U0	5026672U0
▲ Yellow	20	5026663U0	5026668U0	5026673U0
▲ Red	25	5026664U0	5026669U0	5026674U0
▲ Green	35	5026665U0	5026670U0	5026675U0
▲ White	45	5026666U0	5026671U0	5026676U0



XP-3D™

XP-3D addresses the shortcomings of traditional NiTi instrumentation and ushers in a new biologic standard of care in endodontic instrumentation.

Conventional NiTi files can only create round shapes, forcing clinicians to choose between underpreparation or overpreparation of the canal. XP-3D adapts to the canal and cleans three-dimensionally with very low stress to the instrument and the dentin:

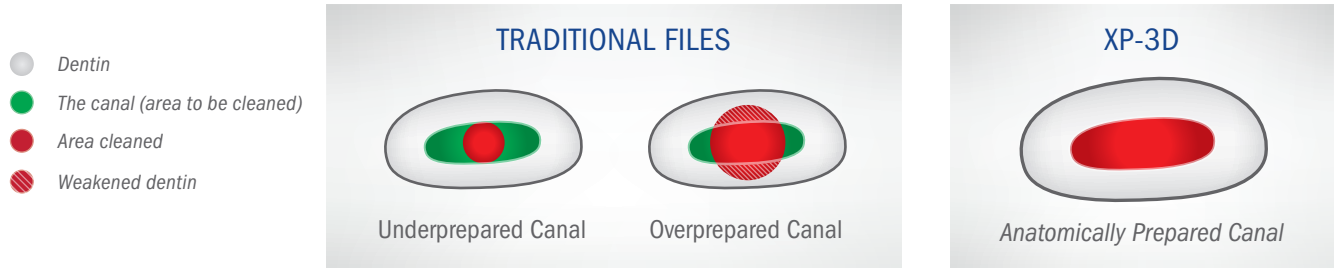

The patented XP-3D Shaper safely, efficiently and effectively cleans the root canal system three-dimensionally while respecting the canal anatomy. As it rotates, the instrument's orbit expands and contracts to abrade the broad and narrow aspects of the canal equally. This intuitive micro mechanical debridement allows the practitioner to utilize a single instrument to safely and efficiently clean and enlarge the canal while respecting the original canal morphology.

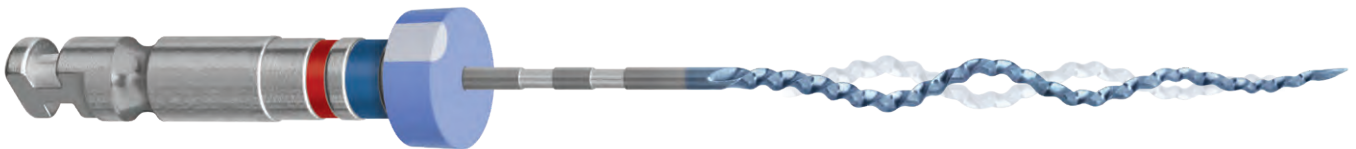

XP-3D Shaper (3/Pack)

File/Tip ID	Tip Size	21 mm (Stopper)	25 mm (Stopper)	31 mm (Stopper)
▲ Blue	30	5025897U0	5028598U0	5028599U0

Like the XP-3D Shaper, the XP-3D Finisher utilizes Brasseler's exclusive MaxWire Technology to adapt to the canal's natural anatomy. The XP-3D Finisher has a bowed shape at body temperature and is incredibly flexible. The instrument debrides the root canal system three-dimensionally and allows for enhanced irrigation. Unlike the XP-3D Shaper, the XP-3D Finisher is intended to clean a prepared canal and will not change the shape once prepared.



XP-3D Finisher (3/Pack)

File/Tip ID	Tip Size	21 mm (Stopper)	25 mm (Stopper)
▲ Red	25	5025842U0	5024933U0
▲ Blue	30	5025844U0	5025843U0

Patent Pending

THE MAXWIRE® EFFECT

Featuring Brasseler's exclusive MaxWire® Technology, XP-3D adapts to the canal's natural anatomy by expanding once exposed to body temperature.

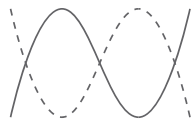

MaxWire

- Super elasticity, extreme flexibility and resistance to cyclic fatigue
- Transformation to a robust, predefined serpentine shape at body temperature 95°F (35°C)
- Ability to gently expand to the natural anatomy of the root canal

68°F (20°C)

M-PHASE

Martensitic Phase

At or below room temperature the instrument is very malleable and has a relaxed serpentine shape.

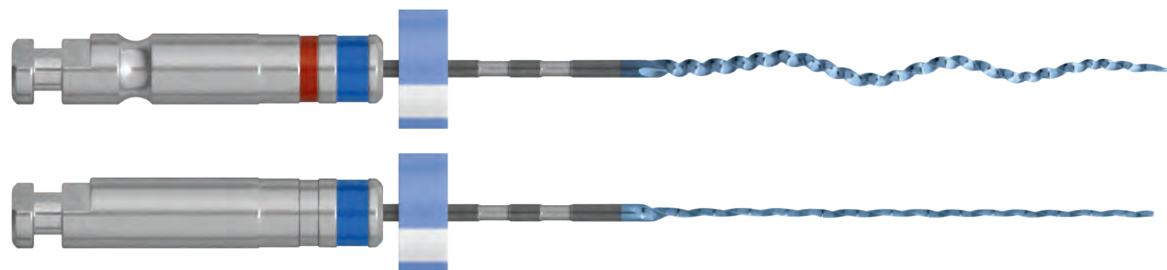

Soft Shape

95°F (35°C)

A-PHASE

Austenitic Phase

When introduced to warmer temperatures (>95°F), the instrument transitions to a more robust serpentine shape.

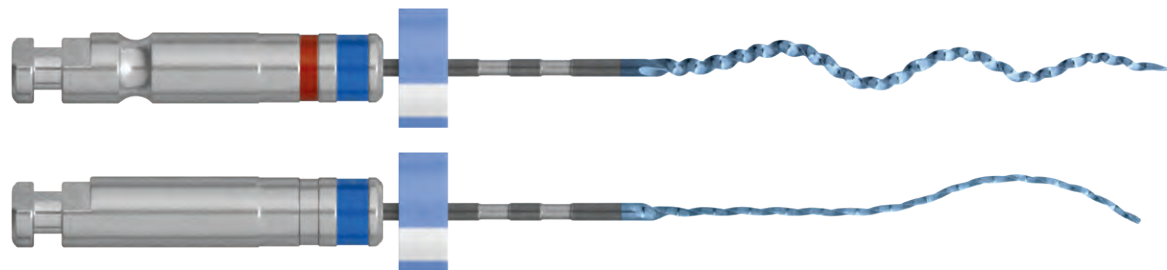

Memorized Shape

THE ULTIMATE RETREATMENT INSTRUMENT

The XP-3D Shaper and XP-3D Finisher R (#30) are excellent for retreatment. For optimal results, use at 1,500 RPM.



Images courtesy of Dr. Klaus Lauterbach, Germany

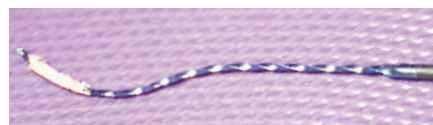

Image courtesy of Dr. Rina Campbell Beckles, Union City, CA

Patent Pending

EndoSequence® Precision Endodontic System

EndoSequence is the first endodontic system to be fully synchronized from instrumentation through obturation and post placement. The constant tapered EndoSequence rotary files contain many patented features which provide unparalleled efficiency and safety. The EndoSequence BC Points and Fiber Posts are laser verified to precisely match the shape (tip/taper) created by the files and the system utilizes the revolutionary, award winning BC Sealer. Join the thousands of others that have discovered the host of benefits that EndoSequence brings to their practice!



NiTi FILE SYSTEMS

THE PATENTED ENDOSEQUENCE FILE DESIGN

EndoSequence is the only file in the world that contains all of the following features:

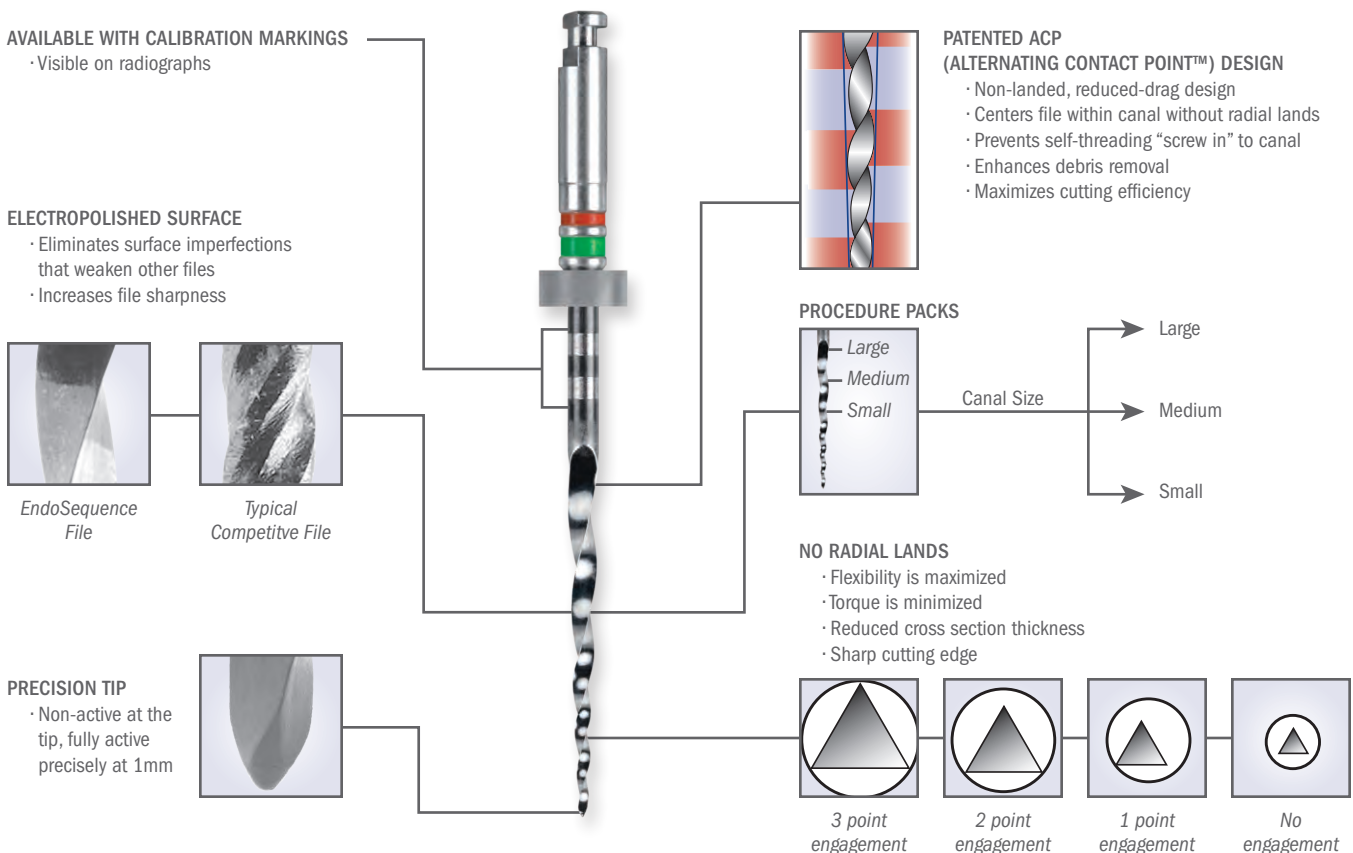

EndoSequence® Rotary Files

Individual Packs (4/Pack)



File/Tip ID	Tip Size	.04 Taper			.06 Taper			.08 Taper
		21 mm	25 mm	31 mm	21 mm	25 mm	31 mm	16 mm
▲ Orange	27	5008966U0	-	-	-	-	-	-
△ White	15	5008967U0	5008981U0	5008995U0	5008973U0	5008987U0	5009001U0	-
▲ Yellow	20	5008968U0	5008982U0	5008996U0	5008974U0	5008988U0	5009002U0	5027183U0*
▲ Red	25	5008969U0	5008983U0	5008997U0	5008975U0	5008989U0	5009003U0	-
▲ Blue	30	5008970U0	5008984U0	5008998U0	5008976U0	5008990U0	5009004U0	-
▲ Green	35	5008971U0	5008985U0	5008999U0	5013140U0	5011647U0	5013147U0	-
▲ Black	40	5008972U0	5008986U0	5009000U0	5013141U0	5013144U0	5013148U0	-
△ White	45	5011831U0	5011836U0	5011841U0	5013142U0	5013145U0	5013149U0	-
▲ Yellow	50	5011832U0	5011837U0	5011842U0	5013143U0	5013146U0	5013150U0	-
▲ Red	55	5011833U0	5011838U0	5011843U0	-	-	-	-
▲ Blue	60	5011834U0	5011839U0	5011844U0	-	-	-	-
▲ Green	70	5014388U0	5014389U0	5014390U0	-	-	-	-
▲ Black	80	5014391U0	5014392U0	5014393U0	-	-	-	-

Assorted Procedure Packs

File/Tip ID	Tip Size	.04 Taper			.06 Taper		
		21 mm	25 mm	31 mm	21 mm	25 mm	31 mm
Small	30-15	5009009U0	5009010U0	5009011U0	5009015U0	5009016U0	5009017U0
Medium	40-25	5009012U0	5009013U0	5009014U0	5013151U0	5013152U0	5013153U0
Large	50-35	5014382U0	5014383U0	5014384U0	5013154U0	5013155U0	5013156U0
Extra-Large	55-80	5014385U0	5014386U0	5014387U0	-	-	-

*Orifice Shaper

Individual Packs - Calibrated (4/Pack)

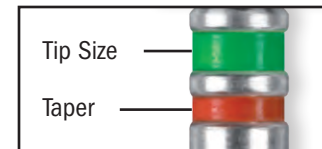
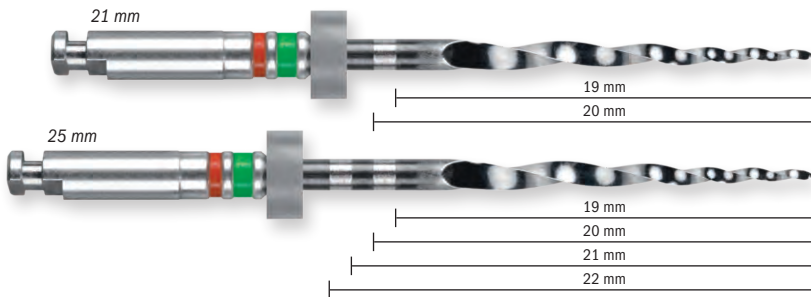

File/Tip ID	Tip Size	.04 Taper		.06 Taper	
		21 mm	25 mm	21 mm	25 mm
△ White	15	5019101U0	5019113U0	5019153U0	5019161U0
▲ Yellow	20	5019102U0	5019114U0	5019154U0	5019162U0
▲ Red	25	5019103U0	5019115U0	5019155U0	5019163U0
▲ Blue	30	5019104U0	5019116U0	5019156U0	5019164U0
▲ Green	35	5019105U0	5019117U0	5019157U0	5019165U0
▲ Black	40	5019106U0	5019118U0	5019158U0	5019166U0
△ White	45	5019107U0	5019119U0	5019159U0	5019167U0
▲ Yellow	50	5019108U0	5019120U0	5019160U0	5019168U0
▲ Red	55	5019109U0	5019121U0	-	-
▲ Blue	60	5019110U0	5019122U0	-	-
▲ Green	70	5019111U0	5019123U0	-	-
▲ Black	80	5019112U0	5019124U0	-	-

Note: See Obturation section for matching gutta percha and paper points

Torque Setting: 1.8 - 2.3 Ncm
Speed Setting: 500 - 600 RPM

ESX® PHILOSOPHY

- The restoration of an endodontically treated tooth begins at the apex.
- The cleaning and shaping instruments should be minimally invasive and preserve the structural integrity of the tooth.
- The obturation materials should bond to the root canal walls, thereby strengthening the root.
- When a post is necessary, it should not put undue stress on the root. It should have a similar modulus of elasticity to that of dentin and it should match the shape created by the last instrument used to shape the canal.
- The system should be as safe and efficient as possible and every component should be designed to maximize the long term prognosis of the tooth.



ESX®: TWO-FILE SHAPING SYSTEM

RESPONSIBLE AND MINIMALLY INVASIVE

- Unlike other "simplified" file systems which utilize from one to three files, the ESX® system does not suggest that the practitioner finish specific canals to a pre-determined size. A "cookie cutter" approach can lead to under-and-over-preparation of canals.
- The ESX® system utilizes the Expeditor™ file (#15/.05) to help the practitioner select the appropriate final apical size for each canal based on its unique anatomy.
- Unlike other systems, the ESX® system is designed to preserve the maximum amount of coronal tooth structure, thereby maximizing the long-term prognosis of the tooth.

ESX® TECHNIQUE

- Use all ESX® files at 500-600 RPM with a torque setting of 1.5-2.3 Ncm.
- Use a "LIGHT TOUCH" and the "SINGLE STROKE AND CLEAN" technique.
- ESX® Expeditor™ File - Provides initial shaping and helps determine the appropriate finishing file for each canal using the following guidelines:
 - ✓ Significant engagement to obtain WL = Finish with ESX® Small File #25/.04*
 - ✓ Moderate engagement to obtain WL = Finish with ESX® Medium File #35/.04
 - ✓ Minimal engagement to obtain WL = Finish with ESX® Large File #45/.04
 - ✓ No engagement to obtain WL = Finish with ESX® Extra-Large File #55/.04

▶ VIDEO TUTORIAL
 Scan this QR code or visit RestorativeEndo.com for a step-by-step tutorial for the ESX® shaping and obturation technique.



STEP 1

ESX® Expeditor™ File To WL

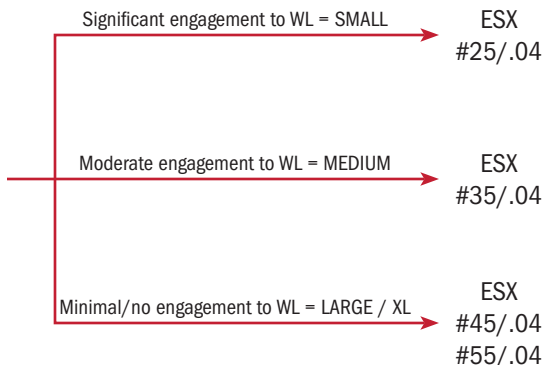

STEP 2

Final ESX® Finishing File To WL

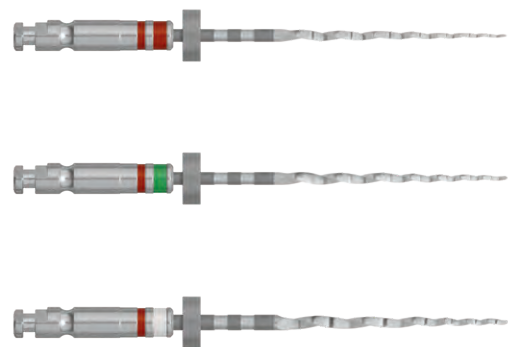

** If ESX® Expeditor™ meets significant resistance consider utilizing the ESX® Scouting Files for initial glide path creation.*

ACCESSORY INSTRUMENTS

The standard ESX® System will successfully prepare the majority of cases. However, some cases (ie. highly calcified and/or severely curved canals) will benefit from the inclusion of one or more of the following specialty files. If the ESX® Expeditor™ meets significant resistance in obtaining working length, the ESX® Orifice Opener and/or ESX® Scouting Files should be utilized to obtain working length.

The Ultimate Orifice Shaper
ESX® 20/.08 (19 mm)



ESX® Scouting Files
ESX® 15/.02 & 15/.04



ESX® PRODUCT OFFERING

All ESX® instruments are sterile packaged in a clean room environment. Each instrument is individually blister packed and each blister is perforated.

Individual Packs (3/Pack)

STERILE R

File/ Tip ID	Tip Size	.02 Taper			.04 Taper			.05 Taper			.08 Taper
		21 mm	25 mm	31 mm	21 mm	25 mm	31 mm	21 mm	25 mm	31 mm	19 mm
△ White	15	5024150U0	5024152U0	-	5024151U0	5024153U0	-	5023991U0*	5023995U0*	5024099U0*	-
▲ Yellow	20	-	-	-	-	-	-	-	-	-	5024291U0
▲ Red	25	-	-	-	5023992U0	5023996U0	5024100U0	-	-	-	-
▲ Blue	30	5024920U0	5024921U0	5024922U0	5024923U0	5024924U0	5024925U0	-	-	-	-
▲ Green	35	-	-	-	5023993U0	5023997U0	5024101U0	-	-	-	-
▲ Black	40	-	-	-	5024926U0	5024927U0	5024928U0	-	-	-	-
△ White	45	-	-	-	5023994U0	5023998U0	5024102U0	-	-	-	-
▲ Red	55	-	-	-	5023989U0	5023990U0	5024103U0	-	-	-	-

* ESX® Expeditor™

QuicKit™ Assortment Packs (6/Pack)

The exclusive ESX® QuicKit™ provides the ideal tray setup for practitioners looking to maximize patient safety and simplify inventory management. The ESX® QuicKit™ contains a sterile #10 and #15 stiff K-file as well as the standard ESX® assortment.

STERILE R

File/ Tip ID	Tip Size	.02 Taper	.04 Taper	.05 Taper	.02 Taper	.04 Taper	.05 Taper
		21 mm			25 mm		
		5023987U0			5023988U0		
■ Purple	10	1/PK	-	-	1/PK	-	-
□ White	15	1/PK	-	-	1/PK	-	-
△ White	15	-	-	1/PK*	-	-	1/PK*
▲ Red	25	-	1/PK	-	-	1/PK	-
▲ Green	35	-	1/PK	-	-	1/PK	-
△ White	45	-	1/PK	-	-	1/PK	-

* ESX® Expeditor™

ScoutRaCe™

ScoutRaCe NiTi rotary files are designed for glide path management. The smaller tip and taper sizes allow practitioners to save time and effort by supplementing their hand filing. While ScoutRaCe files can be used for all cases they are particularly useful for tight, severely calcified or curved canals.

NiTi FILE SYSTEMS

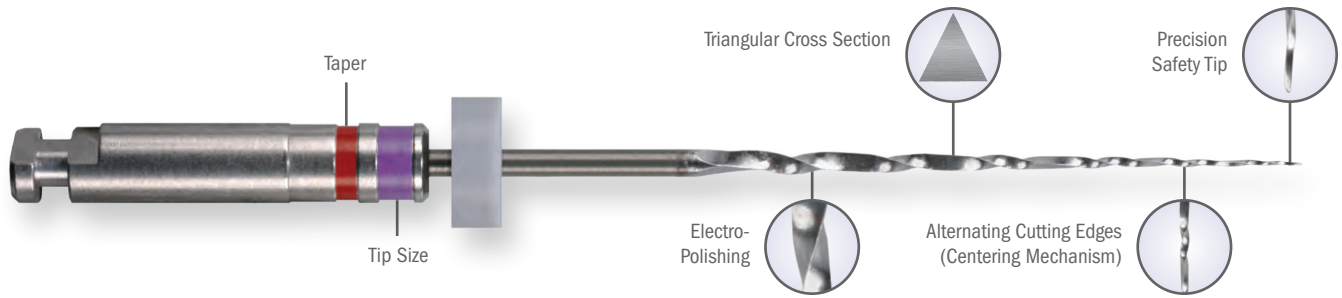

Torque Setting: N/A
 Speed Setting: 600 RPM (curved); 900 RPM (calcified)

Individual Packs (6/Pack)

File/Tip ID	Tip Size	.02 Taper		.04 Taper		.06 Taper	
		21 mm	25 mm	21 mm	25 mm	21 mm	25 mm
▲ Purple	10	5020144U0	5020147U0	5020145U0	5020148U0	5020146U0	5020149U0
△ White	15	5020154U0	5020155U0	-	-	-	-
▲ Yellow	20	5020156U0	5020157U0	-	-	-	-

Assortment Packs (5/Pack)

File/Tip ID	Tip Size	.02 Taper	.04 Taper	.06 Taper	.02 Taper	.04 Taper	.06 Taper	
		21 mm			25 mm			
		5020142U0			5020143U0			
▲ Purple	10	1/PK	1/PK	1/PK	1/PK	1/PK	1/PK	
△ White	15	1/PK	-	-	1/PK	-	-	
▲ Yellow	20	1/PK	-	-	1/PK	-	-	

The BioRaCe Rotary File System is designed to help the practitioner safely and efficiently meet the biologically desirable apical sizes. The system utilizes a modified crown down technique, which varies both the tip size and the taper throughout the sequence. File stress and the subsequent probability of separation is limited because each file is only engaged in a third of the canal during use. Unlike other variable tapered systems, the bottom ~9-11 mm is a constant .04 taper, which expedites obturation.

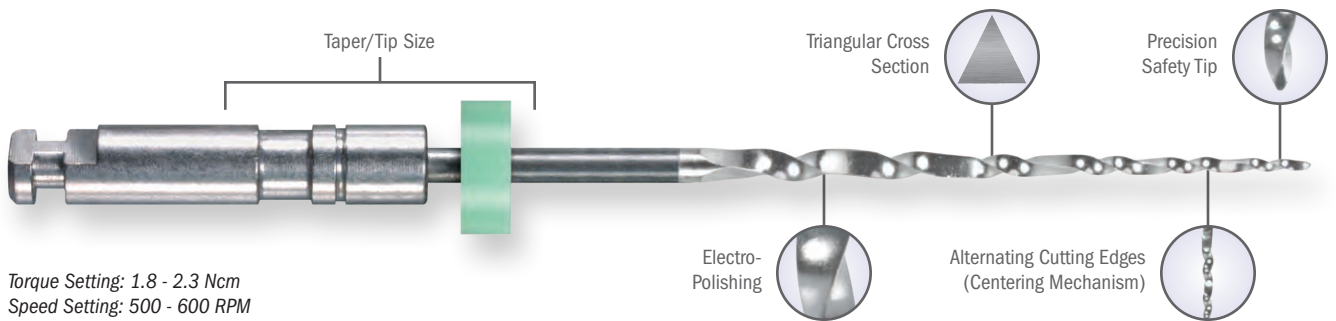
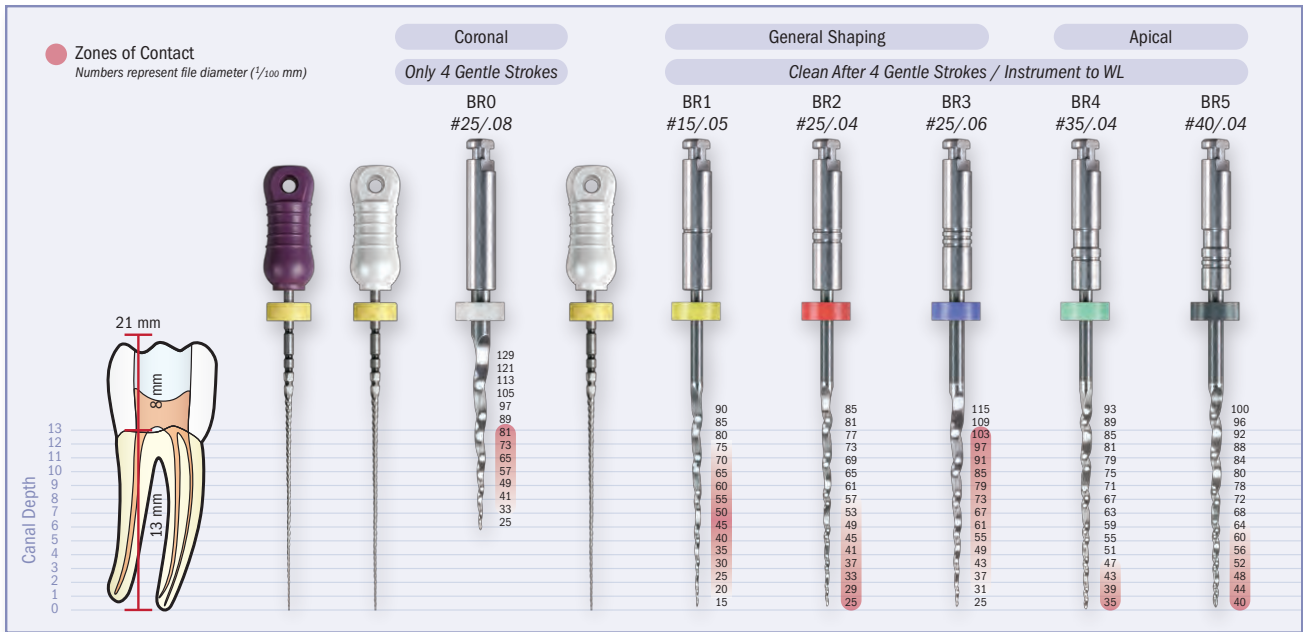

Torque Setting: 1.8 - 2.3 Ncm
Speed Setting: 500 - 600 RPM

Individual & Assortment Packs (6/Pack)

File/Tip ID	File Name	Tip Size	Taper	19mm	21mm	25mm
△ White	BR0	25	.08	5020240U0	-	-
△ Yellow	BR1	15	.05	-	5020241U0	5020238U0
△ Red	BR2	25	.04	-	5020242U0	5020239U0
△ Blue	BR3	25	.06	-	5020247U0	5020246U0
△ Green	BR4	35	.04	-	5019736U0	5019742U0
△ Black	BR5	40	.04	-	5019737U0	5019743U0
Assortment	BASIC SET	BR0-BR5	BR0-BR5	-	5019732U0	5019734U0
△ Green	BR4C	35	.02	-	5019738U0	5019744U0
△ Black	BR5C	40	.02	-	5019739U0	5020139U0
△ Yellow	BR6	50	.04	-	5019740U0	5020140U0
△ Blue	BR7	60	.02	-	5019741U0	5020141U0
Assortment	EXTENDED SET	BR4C-BR7	BR4C-BR7	-	5019733U0	5019735U0

The unique, minimally invasive design of BT RaCe™ allows for the safe treatment of the majority of canals with just three instruments. Research has shown that the natural apical diameters of most roots are surprisingly large and often contain biofilm (in infected cases). Biofilm is up to 1,000 times more difficult to eliminate than floating planktonic microbes.* BT RaCe is designed to help the practitioner safely and efficiently meet the biologically desirable apical sizes without compromising coronal tooth structure, thereby maintaining the strength of the tooth. This unique shaping sequence, together with irrigation and bonded obturation, results in optimal endodontic success and survivability of the tooth.

*Source: Chávez de Paz L., JOE. Volume 33, Number 6, June 2007: 652-662.

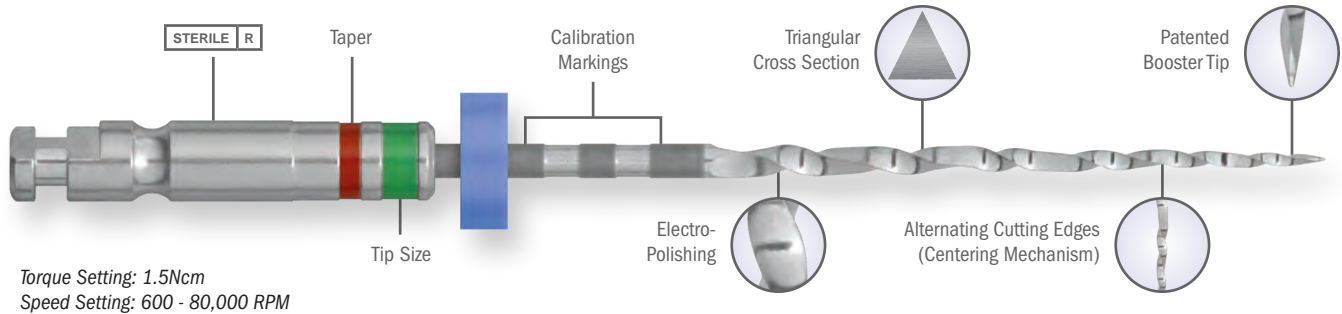

BT RaCe Assortment Packs (3/Pack)

File/Tip ID	Tip Size	.00 Taper			.04 Taper			.06 Taper		
		21 mm (Stopper)	25 mm (Stopper)	5024106U0	21 mm (Stopper)	25 mm (Stopper)	5024107U0	21 mm (Stopper)	25 mm (Stopper)	5024108U0
▲ Purple	10	-	-	1/PK	-	-	1/PK	-	-	-
▲ Green	35	1/PK	-	-	1/PK	-	-	-	-	-
▲ Green	35	-	1/PK	-	-	1/PK	-	-	-	-

BT40 & BT50 Individual Packs (3/Pack)

When larger apical sizes are desired, utilize BT40 (#40/.04) and BT50 (#50/.04). These instruments are pre-sterilized and also contain the patented BT Tip allowing them to safely navigate curved canals despite their larger tip size.

File/Tip ID	Tip Size	.04 Taper	
		21 mm (Stopper)	25 mm (Stopper)
▲ Black	40	5024108U0	5024109U0
▲ Yellow	50	5024110U0	5024111U0

BT RaCe QuickKit™ Assortment Packs (6/Pack)

The exclusive BT RaCe QuickKit provides the ideal tray setup for offices looking to maximize patient safety and simplify inventory management. The BT RaCe QuickKit contains a sterile #8, #10 and #15 RazorFlex file in addition to the standard BT RaCe assortment.

File/Tip ID	Tip Size	.00 Taper			.02 Taper			.04 Taper			.06 Taper		
		21 mm (Stopper)	25 mm (Stopper)	5024104U0	21 mm (Stopper)	25 mm (Stopper)	5024105U0	21 mm (Stopper)	25 mm (Stopper)	5024106U0	21 mm (Stopper)	25 mm (Stopper)	5024107U0
■ Gray	08	-	1/PK	-	-	1/PK	-	-	-	-	-	-	-
■ Purple	10	-	1/PK	-	-	1/PK	-	-	-	-	-	-	-
□ White	15	-	1/PK	-	-	1/PK	-	-	-	-	-	-	-
▲ Purple	10	-	-	-	1/PK	-	-	-	-	-	-	1/PK	-
▲ Green	35	1/PK	-	-	-	1/PK	-	-	-	-	-	-	-
▲ Green	35	-	-	1/PK	-	-	-	-	-	-	1/PK	-	-

The RaCe NiTi Rotary File System utilizes a progressively smaller taper to ensure minimal file stress. The file contains the same patented features as BioRaCe and ScoutRaCe.

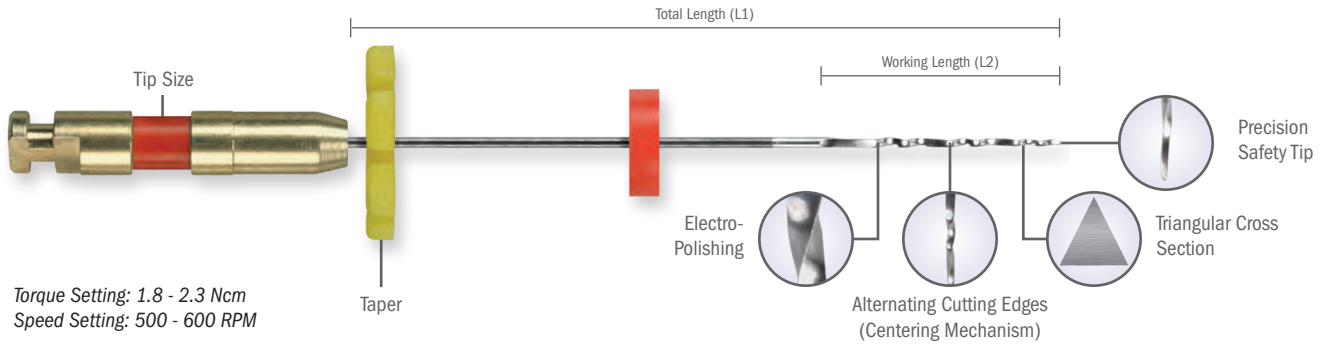

Individual Packs (5/Pack)

File/Tip ID	Tip Size	0.10 Taper	0.08 Taper		0.06 Taper		0.04 Taper		0.02 Taper		
		L1 = 19 mm L2 = 8 mm	L1 = 19 mm L2 = 8 mm	L1 = 19 mm L2 = 9 mm	L1 = 25 mm L2 = 8 mm	L1 = 25 mm L2 = 16 mm	L1 = 25 mm L2 = 8 mm	L1 = 25 mm L2 = 16 mm	L1 = 25 mm L2 = 8 mm	L1 = 25 mm L2 = 16 mm	L1 = 21 mm L2 = 16 mm
△ White	15	-	-	-	-	-	-	-	-	5008667U0	5014972U0
△ Yellow	20	-	-	-	-	-	-	-	-	5008771U0	5014973U0
▲ Red	25	-	5008665U0	-	5008664U0	-	5008663U0	5008781U0	5008662U0	5008782U0	5014974U0
▲ Blue	30	-	-	-	-	5008765U0	-	5008766U0	-	5008770U0	5014975U0
▲ Green	35	-	-	5008764U0	-	-	-	-	-	5008668U0	5014976U0
▲ Black	40	5008666U0	-	-	-	-	-	-	-	5008769U0	5014977U0
▲ Yellow	50	-	-	-	-	-	-	-	-	5008768U0	5014978U0
△ White	60	-	-	-	-	-	-	-	-	5008767U0	5014979U0

Assortment Pack (5/Pack)

File/Tip ID	Tip Size	0.10 Taper	0.08 Taper	0.06 Taper	0.04 Taper	0.02 Taper
		L1 = 19 mm L2 = 8 mm	L1 = 19 mm L2 = 8 mm	L1 = 25 mm L2 = 8 mm	L1 = 25 mm L2 = 8 mm	L1 = 25 mm L2 = 8 mm
5008661U0						
▲ Red	25	-	1/PK	1/PK	1/PK	1/PK
▲ Black	40	1/PK	-	-	-	-

RazorFlex files are manufactured with Brasseler's exclusive Austenite NiTi alloy. The hardened NiTi and modified flute geometry deliver excellent cutting efficiency and torsional resistance. RazorFlex files are subjected to Brasseler's extremely tight quality control standards and exhibit uncompromised performance. The extensive range of tip sizes and tapers allows you to quickly incorporate RazorFlex files into your treatment philosophy.

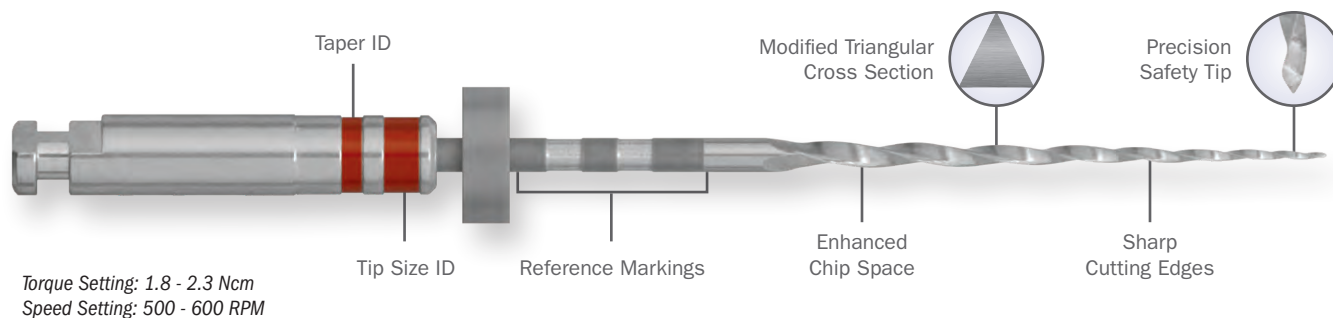

RAZORFLEX™ CLINICAL TIPS

- Always reach full working length to at least a #15/.02 prior to use of rotary files.
- Use a feather-light touch taking the file to engagement (not resistance).
- Use the Single Stroke and Clean Technique. Clean the flutes after each gentle engagement.
- Irrigate between each rotary file.
- Obturate the canals using BC Sealer™ and the corresponding BC Point™.

RAZORFLEX™ PRODUCT OFFERING

Individual Packs (4/Pack)

File/ Tip ID	Tip Size	.04 Taper		.05 Taper		.06 Taper		.08 Taper
		21 mm	25 mm	21 mm	25 mm	21 mm	25 mm	19 mm
△ White	15	5025131U0	5025138U0	–	–	–	–	–
▲ Purple	17	–	–	5025146U0	5025147U0	–	–	–
▲ Yellow	20	5025132U0	5025139U0	–	–	5025148U0	5025149U0	5025145U0
▲ Red	25	5025133U0	5025140U0	5025150U0	5025151U0	–	–	–
▲ Orange	27	5025152U0	–	–	–	–	–	–
▲ Blue	30	5025134U0	5025141U0	5025155U0	5025159U0	–	–	–
▲ Green	35	5025135U0	5025142U0	–	–	–	–	–
▲ Black	40	5025136U0	5025143U0	–	–	–	–	–
△ White	45	5025137U0	5025144U0	–	–	–	–	–
▲ Yellow	50	5025153U0	5025154U0	–	–	–	–	–

EndoSequence® Apical Verifiers

EndoSequence Apical Verifiers feature a unique reverse tapered design which allows the practitioner to safely navigate curved canals without the worry of separation. Another important feature of this design is that it allows you to verify and expand the apical diameter of roots without needlessly weakening the tooth. Use Apical Verifiers anytime that you want to confirm or increase the apical diameter of a canal without removing excessive radicular dentin.

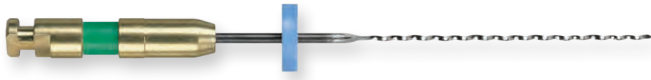

Apical Verifiers (4/Pack)

File/Tip ID	Tip Size	21 mm	25 mm
△ White	15	5018319U0	5018329U0
▲ Yellow	20	5018320U0	5018330U0
▲ Red	25	5018321U0	5018331U0
▲ Blue	30	5018322U0	5018332U0
Assortment	15-30	5018327U0	5018337U0
▲ Green	35	5018323U0	5018333U0
▲ Black	40	5018324U0	5018334U0
▲ Yellow	50	5018325U0	5018335U0
▲ Blue	60	5018326U0	5018336U0
Assortment	35-60	5018328U0	5018338U0

Torque Setting: .5 Ncm
Speed Setting: 500 - 600 RPM

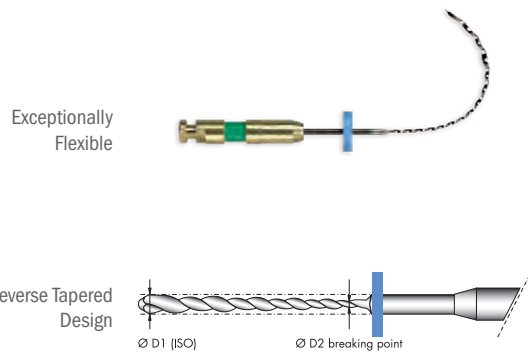

Triton® All-in-One Irrigation Solution



Order No.
5028425U0

Unlike traditional irrigants or other advanced 2:1 solutions, Triton works differently by avoiding the use of EDTA and CHX altogether. The non-NaOCl components in Triton proactively dissolve the dentinal debris allowing for a lower concentration of NaOCl to be exposed to organic debris without as much buffering. Synergistic and simultaneous dissolution of organic and inorganic debris permit the clinician to use lower volumes of irrigation solution and ensure maximum clinical efficiency.

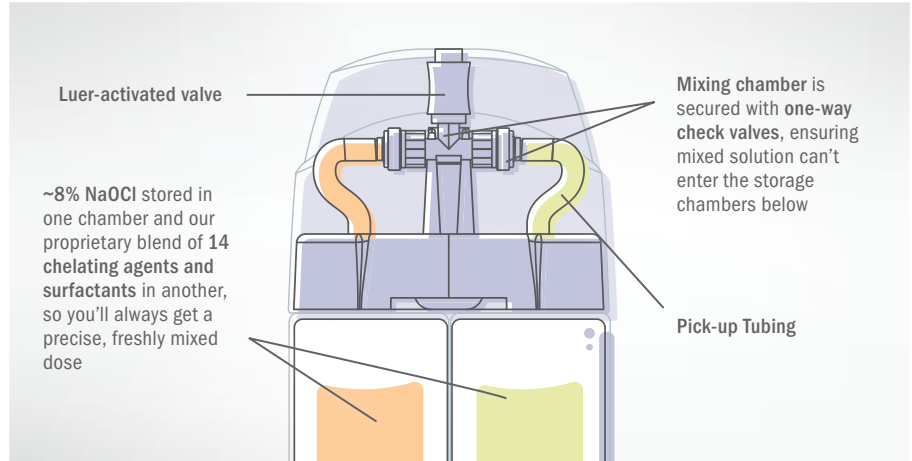

EFFICIENT AND EFFECTIVE

By using a lower concentration of NaOCl and a patent-pending proprietary blend of surfactants and gentle chelating agents, Triton is the first irrigant to deliver all of the benefits of NaOCl, EDTA, and CHX in a single-step all-in-one irrigation solution.

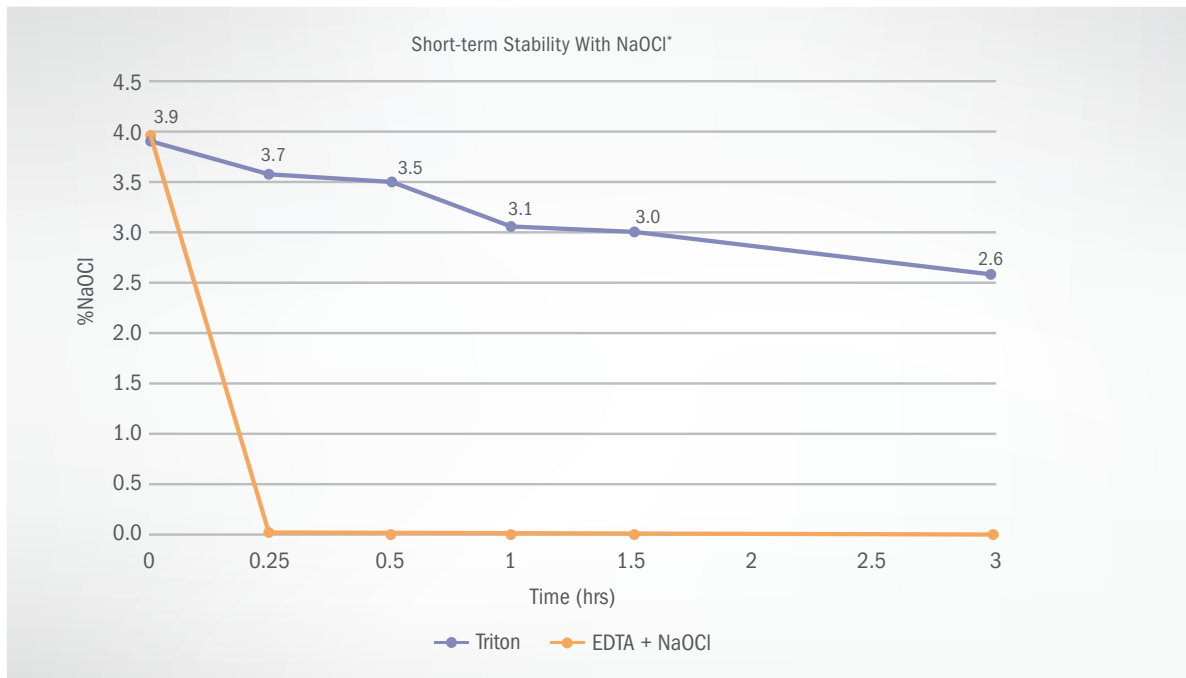

NaOCl is rapidly neutralized upon contact with EDTA (and inorganic dentinal debris). Triton maintains an effective NaOCl concentration for organic tissue dissolution while simultaneously allowing for inorganic debris removal in just one step.

*Internal testing. Data on file.

Triton® All-in-One Irrigation Solution

- Multi-functional single irrigation solution reduces chair time, procedural steps, and overall irrigation costs
- Simultaneous organic and inorganic debris removal
- Patent-pending composition allows for a lower concentration of NaOCl to be used while also delivering improved efficacy
- More effective at smear layer removal vs. NaOCl with EDTA
- Dissolves organic tissue up to 1.7x faster than traditional NaOCl

RESEARCH SUMMARY

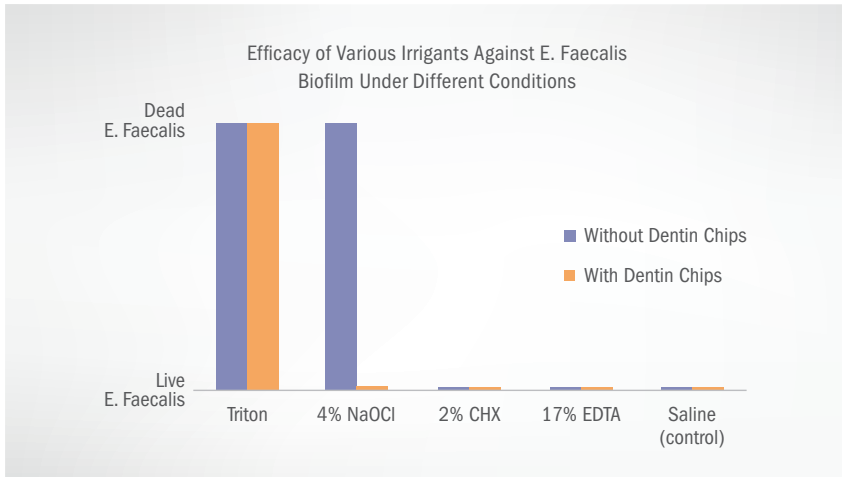

Dr. Karabucak, University of Pennsylvania, Dental Medicine Department of Endodontics (study in review)

EFFECTIVE AGAINST E. FAECALIS BIOFILM

The efficacy of various irrigants against E. Faecalis biofilm was investigated both with and without dentin chips present. In the presence of dentin chips, only Triton was able to eliminate all E. Faecalis.

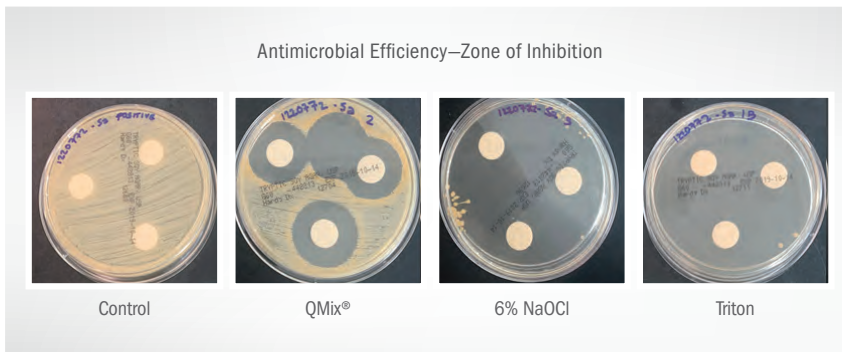

Nelson Labs, Salt Lake City, UT. Study on file.

MICROBES ARE SUSCEPTIBLE TO TRITON

Triton provided the largest zone of inhibition compared to 6% NaOCl and QMix®.

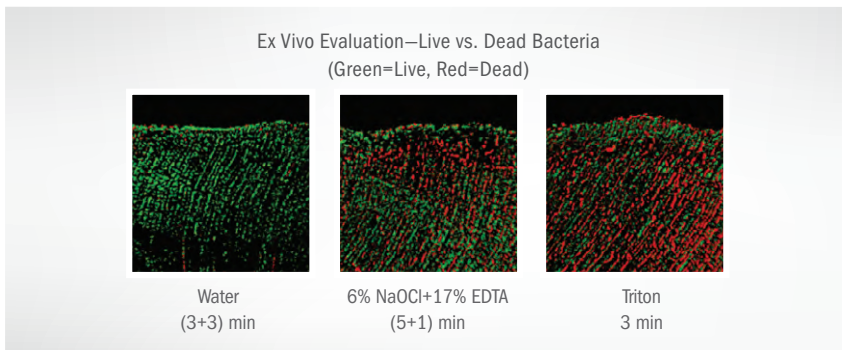

Xuyan Sheng, Zhejun Wang, Ya Shen (UBC)

KILLS MORE BACTERIA QUICKER

In an ex vivo evaluation of live versus dead bacteria comparing three different irrigation protocols, Triton was more effective than 6% NaOCl + 17% EDTA in half the time.

QMix® is a registered trademark of DENTSPLY International.

Endo Solutions

Studies have shown that 15% of store bought NaOCl contains less than 1% available chlorine (which is needed for tissue dissolution and disinfection).* Brasseler USA's Endo Solutions adhere to strict FDA & ISO quality control measures.

**Quintessence Intl 2014;45:467-474; doi:10.3290/j.qi.a31805*

5% Sodium Hypochlorite

- Eliminates bacteria
- Used to irrigate during and after root canal debridement

Volume	Order No.
16 oz.	5026552U0

17% EDTA

- Opens dentinal tubules
- Prepares dentin walls for obturation
- Removes smear layer

Volume	Order No.
16 oz.	5026554U0
32 oz.*	5028445U0

2% Chlorhexidine Gluconate

- Aids in post-op sensitivity
- Increases bond strength

Volume	Order No.
16 oz.	5026553U0



Luer-lock cap reduces cross-contamination and improves solution efficacy.

*Bulk EDTA bottle does not have a luer-lock cap.

Endo Solutions Irrigation Syringes

Brasseler USA's irrigation syringes are ideal for surgical site irrigation and compatible with all luer-lock style needles and hubs. Disposable, non-sterile. Not for injection.

Irrigation Syringes (50/Pack)

Volume	Order No.
3 cc	5026555U0
6 cc	5026882U0

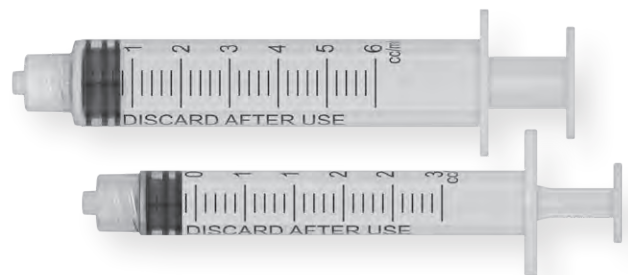

Endo Solutions Irrigation Needles

Designed with a closed-end cannula and a side window dispersal point, Brasseler USA's Irrigation Needles offer a unique design for unmatched effectiveness, patient comfort and safety in irrigating root canals.

Irrigation Needles (20/Pack)

Thickness	21 mm	27 mm
27 Gauge	5026557U0	5026558U0
31 Gauge	5026680U0	5026681U0

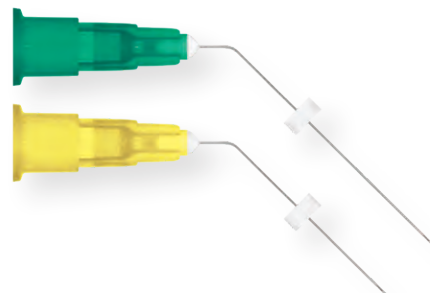

Endo Solutions Caddy

Features 3 forward-angled slots for standard Endo Solution bottles, 3 large base compartments and slots to accommodate up to 12 syringes (8 x 3cc & 4 x 6cc).

Contents not included with caddy

Order No.
5026556U0



EndoSequence® Lubricant

- Chelating agent
- Syringe and disposable tips make application and cleanup quick and easy
- Blue color provides reassurance that all of the EDTA has been removed prior to obturation
- Cream consistency provides increased surface tension allowing the lubricant to better adhere to files

Active Ingredients:

- EDTA: 15%
- Urea Peroxide: 10%

Packaging Unit	Order No.
Three 3g Syringes	5015119U0



EndoSequence® Canal Clean™

- Removes the smear layer
- Works in less than a minute
- Opens and cleans the dentinal tubules creating an optimal surface for endodontic sealers
- Low surface tension: surfactants allow Canal Clean to penetrate dentinal tubules and remove smear plugs
- Reduced EDTA formula: prevents the undesired breakdown of dentin

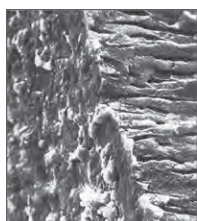

Before Canal Clean

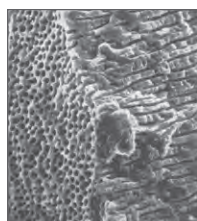

After Canal Clean

Active Ingredients:

- EDTA: 3%
- Cocoamphodiacetate (surfactant)
- Benzalkoniumchloride (anti-bacterial)

Packaging Unit	Order No.
100 mL	5013409U0
250 mL	5013410U0



YOUR TRUSTED LEADER IN BIOACTIVES...

Brasseler has revolutionized Endodontics and helped establish a new biologic standard of care in obturation.

Consider the paradigm shift in restorative dentistry, moving from retentive form preparations with non-bonded amalgam to minimally invasive preparations with bonded composites. With the introduction of bioceramic bonded obturation, a similar paradigm shift has occurred in endo obturation. Because conventional sealers shrink and don't bond to dentin, clinicians had to over-enlarge the canal to facilitate the placement and compaction of gutta percha to minimize the sealer interface. BC Sealer exhibits absolutely zero shrinkage and bonds to dentin through hydroxyapatite formation, allowing us to fully embrace minimally invasive shaping and cleaning protocols.

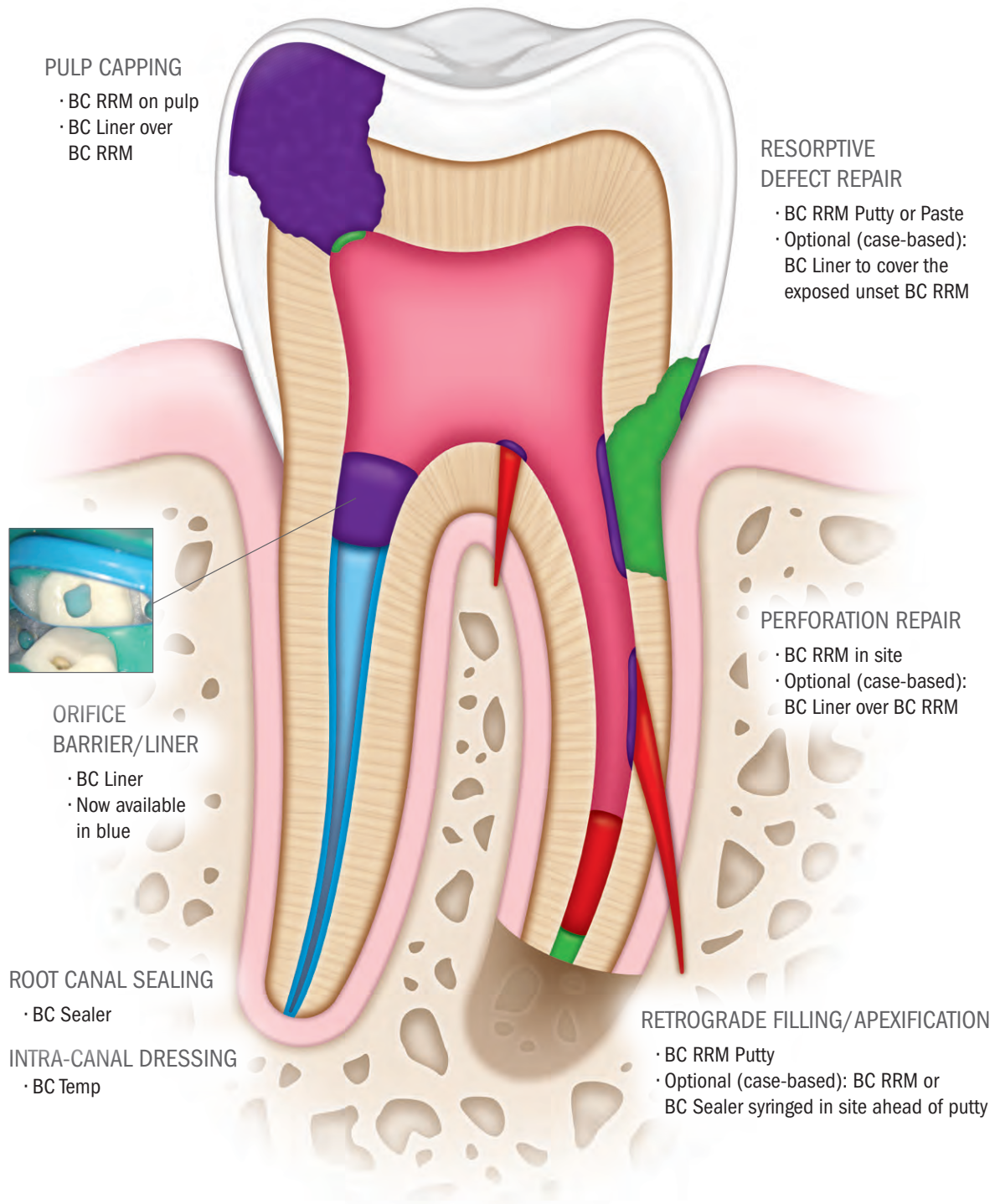

ENDOSEQUENCE® BC SEALER™

- Premixed pure bioceramic
- The market's leading sealer
- Biocompatible and antibacterial

*Prefer warm
obturation techniques?
Try BC Sealer HiFlow™!*



ENDOSEQUENCE® BC TEMP™

- Single or less frequent application
- Highly biocompatible
- Optimal pH

ENDOSEQUENCE® BC LINER™ (WHITE OR BLUE)

- RMGI optimized for use with BC Sealer/RRM
- Self-bonding and dual-cure
- Strong (241 mPA) and versatile
- Excellent for orifice barriers



ENDOSEQUENCE® BC RRM™

- Premixed pure bioceramic (flowable)
- Biocompatible and osteogenic
- Optimal for repairing sites difficult to reach with putty



ENDOSEQUENCE® BC RRM™ FAST-SET PUTTY

- Premixed pure bioceramic (condensable putty)
- Biocompatible and osteogenic
- Highly resistant to washout with optimal handling

EndoSequence® BC Sealer™

Unlike conventional base/catalyst sealers, BC Sealer utilizes the moisture naturally present in the dentinal tubules to initiate its setting reaction. This highly radiopaque and hydrophilic sealer forms hydroxyapatite upon setting and chemically bonds to both dentin and to our bioceramic points (EndoSequence BC Points). BC Sealer is anti-bacterial during setting due to its highly alkaline pH and unlike traditional sealers, BC Sealer exhibits absolutely zero shrinkage!



BC Sealer™ HiFlow™ is optimized for warm obturation techniques

EndoSequence® BC Sealer:

- 1 2g syringe
- 15 Intra-Canal Tips
- 1 Instructions for Use (IFU)
- 1 Safety Data Sheet (SDS)

Order No. 5017560U0

EndoSequence® BC Sealer Bulk:

- 2 1.6g syringe
- 25 Intra-Canal Tips
- 1 Instructions for Use (IFU)
- 1 Safety Data Sheet (SDS)

Order No. 5029291U0

EndoSequence® BC Sealer™ HiFlow™:

- 1 1.5g syringe
- 15 Intra-Canal Tips
- 1 Instructions for Use (IFU)
- 1 Safety Data Sheet (SDS)

Order No. 5026825U0



EndoSequence® Minimum Waste BC Tips

87% less waste vs. standard tips

Qty/Pk	Order No.
15	5027507U0
50	5028585U0

BIOCERAMIC BONDED OBTURATION

Standard gutta percha can be used with BC Sealer, but for a true, gap-free seal, BC Points are recommended. BC Points are impregnated and coated with bioceramic particles to allow for bonding with BC Sealer. The benefit of using BC Sealer and BC Points is that three-dimensional bonded obturation can be achieved at room temperature. However, if a warm vertical technique is preferred it is recommended to use BC Sealer HiFlow with BC Points 150 Series along with BC Pellets at 150°C - 220°C.

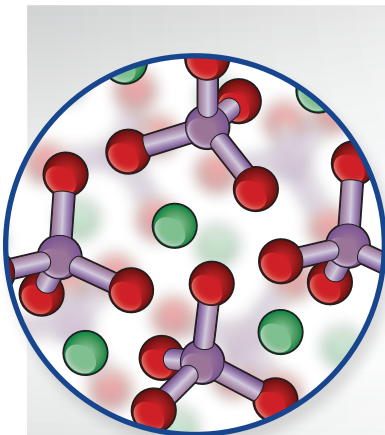

BC SEALER SETTING/BONDING REACTION

BC Sealer is a calcium silicate, calcium phosphate based sealer. The calcium silicate combines with water to form calcium hydroxide (high pH). The calcium hydroxide then combines with calcium phosphate to form hydroxyapatite.

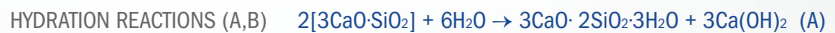

HYDROXYAPATITE

NEVER BEFORE HAS AN OBTURATION SYSTEM BEEN ABLE TO MAKE THESE CLAIMS.*
HOW DOES YOUR CURRENT SYSTEM COMPARE?

	BC Sealer and Points	Your Current System
Biocompatible and Osteogenic	✓	?
Chemical Bond of Sealer to Dentin	✓	?
Chemical Bond of Sealer to Filling Material	✓	?
Cost Effective (Considerably Less Expensive Than Carriers)	✓	?
Highly Antibacterial (12+ pH upon setting)	✓	?
Highly Radiopaque	✓	?
Hydrophilic	✓	?
Hydroxyapatite Producing	✓	?
Ideal Working and Setting Time	✓	?
User Friendly (Premixed Syringable Sealer)	✓	?
Zero Shrinkage of Sealer and Filling Material	✓	?
3-D Bonded Obturation at Room Temperature	✓	?

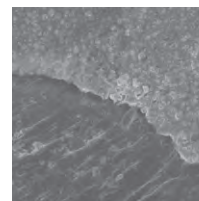

EndoSequence BC Sealer / BC Point Interface

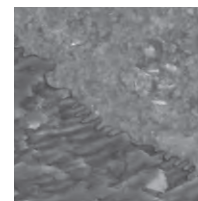

EndoSequence BC Sealer / Dentin Interface



Radiograph courtesy of Dr. Gilberto Debelian, DMD, PhD, Adjunct Associate Professor, Dept of Endodontics at Universities of North Carolina and Pennsylvania



Micro CT Courtesy of Dr. Adam Lloyd, Chair of Department of Endodontics, UTHSC

*Research and other support materials available at www.BrasselerUSA.com/Bioceramics



BC Obturation Kit (.04 Taper):

- 1 BC Sealer
- 15 Intra-Canal Tips
- 1 Assorted BC Points Wheel (.04 Taper)
- 1 Instructions for Use (IFU)
- 1 Safety Data Sheet (SDS)

Order No. 5019504U0

BC Obturation Kit (.06 Taper):

- 1 BC Sealer
- 15 Intra-Canal Tips
- 1 Assorted BC Points Wheel (.06 Taper)
- 1 Instructions for Use (IFU)
- 1 Safety Data Sheet (SDS)

Order No. 5019505U0

EndoSequence® BC Points™ – Cold Bonded Obturation

BC Points™ (60/Pack)

Stiffer to drive sealer



Tip ID	Tip Size	.04 Taper	.06 Taper
○ White	15	5019508U0	5019520U0
● Yellow	20	5019509U0	5019521U0
● Red	25	5019510U0	5019522U0
● Blue	30	5019511U0	5019523U0
● Green	35	5019512U0	5019524U0
● Black	40	5019513U0	5019525U0
○ White	45	5019514U0	5019526U0
● Yellow	50	5019515U0	5019527U0
● Red	55	5019516U0	-
● Blue	60	5019517U0	-
● Green	70	5019518U0	-
● Black	80	5019519U0	-



BC Obturation Wheel (.04 Taper):

15 ea. (sizes 15-60) BC Points (.04 Taper)
15 ea. (sizes 15-60) Paper Points (.04 Taper)

Order No. 5019506U0

BC Obturation Wheel (.06 Taper):

15 ea. (sizes 15-50) BC Points (.06 Taper)
15 ea. (sizes 15-50) Paper Points (.06 Taper)

Order No. 5019507U0

EndoSequence® BC Points™ & Pellets™ – Warm Bonded Obturation

150 Series BC Points™ (60/Pack)

Melt at 150°C



Tip ID	Tip Size	.04 Taper
○ White	15	5024583U0
● Yellow	20	5024584U0
● Red	25	5024585U0
● Blue	30	5024586U0
● Green	35	5024587U0
● Black	40	5024588U0
○ White	45	5024589U0
● Red	55	5024590U0

ESR™ BC Points™ (60/Pack)



Tip ID	Tip Size	Order No.
● Yellow	20	5026705U0
● Red	25	5026706U0
● Green	35	5026707U0
○ White	45	5026708U0
Assortment	20-45	5026813U0

CM Taper™ BC Points™ (60/Pack)



Tip ID	Tip Size	Order No.
● Yellow	F1	5028547U0
● Red	F2	5028548U0
● Blue	F3	5028549U0
● Black	F4	5028550U0
Assortment	F1-F4	5028551U0

Scout BC Points™ (60/Pack)



Tip ID	Tip Size	.04 Taper
○ White	15	5027194U0
● Yellow	20	5027195U0
● Red	25	5027196U0
● Blue	30	5027197U0
● Green	35	5027198U0
● Black	40	5027199U0
○ White	45	5027200U0

BC Pellets™ (100/Pack)

Melt at 150°C

Order No. 5023074U0

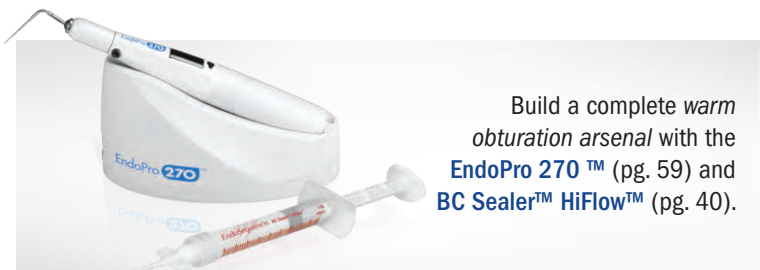

Build a complete warm obturation arsenal with the EndoPro 270™ (pg. 59) and BC Sealer™ HiFlow™ (pg. 40).

EndoSequence® Gutta Percha & Paper Points

- Designed to precisely match the constant tapered preparation created by the EndoSequence file (.04, .06)
- Exhibit extremely tight quality assurance tolerances
- Calibration markings for quick and accurate depth measurements
- Undergo a proprietary stiffening process

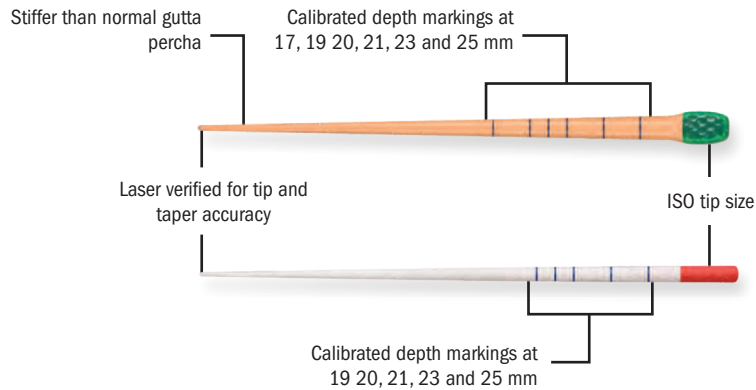

Gutta Percha Points (60/Pack)

Tip ID	Tip Size	.04 Taper	.06 Taper
○ White	15	5017949U0	5017961U0
● Yellow	20	5017950U0	5017962U0
● Red	25	5017951U0	5017963U0
● Blue	30	5017952U0	5017964U0
● Green	35	5017953U0	5017965U0
● Black	40	5017954U0	5017966U0
○ White	45	5017955U0	5017967U0
● Yellow	50	5017956U0	5017968U0
● Red	55	5017957U0	-
● Blue	60	5017958U0	-
● Green	70	5017959U0	-
● Black	80	5017960U0	-

Paper Points (90/Pack)

Tip ID	Tip Size	.04 Taper	.06 Taper
○ White	15	5017969U0	5017981U0
● Yellow	20	5017970U0	5017982U0
● Red	25	5017971U0	5017983U0
● Blue	30	5017972U0	5017984U0
● Green	35	5017973U0	5017985U0
● Black	40	5017974U0	5017986U0
○ White	45	5017975U0	5017987U0
● Yellow	50	5017976U0	5017988U0
● Red	55	5017977U0	-
● Blue	60	5017978U0	-
● Green	70	5017979U0	-
● Black	80	5017980U0	-



EndoSequence® Obturation Wheel (.04 Taper):

15 ea. (sizes 15-60) Gutta Percha Points (.04 Taper)
 15 ea. (sizes 15-60) Paper Points (.04 Taper)

Order No. 5017989U0

EndoSequence® Obturation Wheel (.06 Taper):

15 ea. (sizes 15-50) Gutta Percha Points (.06 Taper)
 15 ea. (sizes 15-50) Paper Points (.06 Taper)

Order No. 5017990U0

Activ GP™ Sealer

The unique benefits of a modified glass ionomer sealer:

- Ideal for single visit RCT and post and core (15 minute working time)
- Excellent biocompatibility
- Bonded obturation
- Highly radiopaque

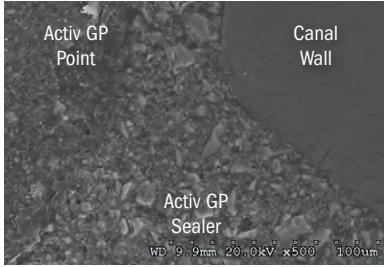

Liquid



Order No. 5011494U0

Powder



Order No. 5011493U0

Activ GP™ Points

Activ GP Points exhibit all of the same characteristics of our BC Points, but they are coated and impregnated with *glass ionomer* particles for optimal bonding with ActivGP Sealer. Another distinguishing feature is that Activ GP Points contain calibration (depth) markings.

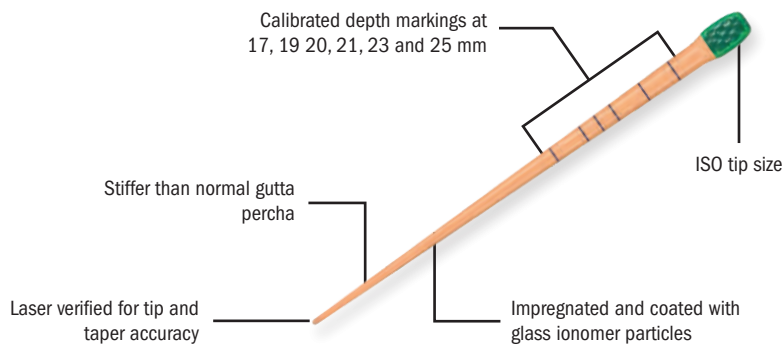

Individual Packs (60/Pack)

Tip ID	Tip Size	.04 Taper	.06 Taper
○ White	15	5017993U0	5018005U0
● Yellow	20	5017994U0	5018006U0
● Red	25	5017995U0	5018007U0
● Blue	30	5017996U0	5018008U0
● Green	35	5017997U0	5018009U0
● Black	40	5017998U0	5018010U0
○ White	45	5017999U0	5018011U0
● Yellow	50	5018000U0	5018012U0
● Red	55	5018001U0	-
● Blue	60	5018002U0	-
● Green	70	5018003U0	-
● Black	80	5018004U0	-



Activ GP™ Obturation Wheel (.04 Taper):

- 15 ea. (sizes 15-60) Activ GP Points (.04 Taper)
- 15 ea. (sizes 15-60) Paper Points (.04 Taper)

Order No. 5017991U0

Activ GP™ Obturation Wheel (.06 Taper):

- 15 ea. (sizes 15-50) Activ GP Points (.06 Taper)
- 15 ea. (sizes 15-50) Paper Points (.06 Taper)

Order No. 5017992U0

Standard & Accessory Gutta Percha

Standard Gutta Percha (120/Pack)

- .02 taper
- Used for lateral or vertical condensation



Tip ID	Tip Size	30 mm
○ White	15	5009239U0
● Yellow	20	5009240U0
● Red	25	5009241U0
● Blue	30	5009242U0
● Green	35	5009243U0
● Black	40	5009244U0
○ White	45	5009245U0
● Yellow	50	5009246U0
● Red	55	5009247U0
● Blue	60	5009248U0
● Green	70	5009249U0
● Black	80	5009250U0
Assortment	15-40	5009251U0

Gutta Percha Accessories (100/Pack)

- Used in conjunction with larger cones for lateral or vertical condensation



Tip Size	30 mm
XF	5009233U0
FF	5009235U0
MF	5009238U0
F	5009234U0
FM	5009236U0
M	5009237U0

Finger Spreaders & Finger Pluggers

- Spreaders are used for lateral condensation; Pluggers are used for vertical condensation
- Manufactured of high quality stainless steel
- Ideal combination of strength and flexibility
- For added flexibility, use our NiTi Spreaders



Finger Spreaders (6/Pack)

Tip ID	Tip Size	25 mm	
		Stainless Steel	NiTi
○ White	15	-	5007087U0
● Yellow	20	5007074U0	5007088U0
● Red	25	5007075U0	5007089U0
● Blue	30	5007076U0	5007090U0
● Green	35	5007077U0	5007091U0
● Black	40	5007078U0	5007092U0
Assortment	15-40	5007079U0	5007093U0

Finger Pluggers - Stainless Steel (6/Pack)

Tip ID	Tip Size	25 mm
○ White	15	-
● Yellow	20	-
● Red	25	5007082U0
● Blue	30	5007083U0
● Green	35	-
● Black	40	-
Assortment	15-40	5007086U0

Paste Fillers

EndoSequence® BC Paste Fillers (4/Pack)

- Unique handle can be used with all latch type contra-angle handpieces on the market
- Exclusive automatic safety clutch for stress-free work



Tip ID	Tip Size	21 mm	25 mm
● Red	25	5027822U0	5027825U0
● Blue	30	5027823U0	5027826U0
● Green	35	5027824U0	5027827U0

Paste Fillers (4/Pack)

- Used in low speed latch type handpieces
- Precision spirals deliver sealers, cements and medicaments evenly throughout the canal



Tip ID	Tip Size	21 mm	25 mm
● Red	25	5014473U0	5014477U0
● Blue	30	5014474U0	5014478U0
● Green	35	5014475U0	5014479U0
● Black	40	5014476U0	5014480U0

EndoSequence® BC Temp™

BC Temp is a premixed bioceramic paste for intracanal dressing. Unlike traditional Calcium Hydroxide pastes, the primary components of BC Temp are Calcium Silicates and Calcium Oxide which combine with the water naturally present in dentin to produce Calcium Hydroxide which dissociates into Ca^{2+} and OH^- . The hydroxyl ions (OH^-) released are responsible for a significant increase in the pH of the surrounding tissues, making the environment unsuitable for bacterial growth. The hydration reaction of Calcium Silicates allows BC Temp to have a gradual and slow release of calcium and hydroxyl ions which eliminates the need for frequent applications.

- Single or less frequent application
- Highly biocompatible
- Optimal pH
- Easily removed
- High radiopacity
- Non-staining
- Optimal flow - $23,85 \pm 0,33$ mm



EndoSequence® BC Temp™:

- 4 .5g Syringes
- 20 Delivery Tips
- 1 Safety Data Sheet (SDS)

Order No. 5027169U0

BC Temp is highly radiopaque ($>9\text{mm}$) and utilizes Calcium Tungstate as a radiopacifier so it is non staining and unlike conventional Calcium Hydroxide materials, BC Temp is easily removed which reduces chair time.

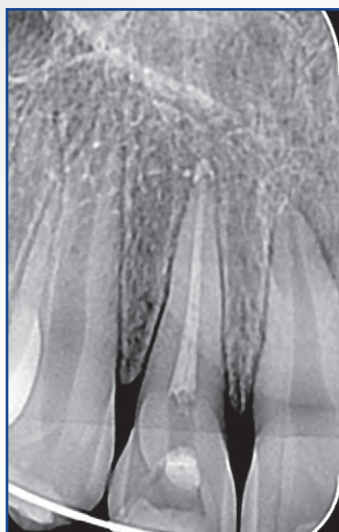

Initial X-Ray

Radiograph after initial placement of BC Temp



Final X-Ray

Final obturation; 15 days after initial placement of BC Temp

*Images courtesy of Dr. Kely F. Bruno
Universidade Federal de Goiás, Goiânia, GO, Brazil*

WHY UPGRADE TO BC TEMP?

GRADUAL AND SUSTAINED RELEASE OF BOTH HYDROXYL AND CALCIUM IONS

BC Temp is composed of calcium silicates and calcium oxide, which create Ca(OH)₂ when exposed to moisture in the root canal. BC Temp has three different crystalline structures, each with a distinct rate of hydration: This gradual/staged release eliminates the need for frequent applications. Traditional intracanal dressings start as Ca(OH)₂ and have a larger particle size, which leads to faster disassociation of calcium and hydroxyl ions. Furthermore, BC Temp's unique formulation releases more calcium ions than traditional Ca(OH)₂, which makes it more effective at hard tissue formation and faster healing of periapical lesions.*

Mean ± standard deviation for calcium ions (mg/dL) released according to the experimental groups at different times

Groups	7 Days	14 Days	21 Days
BC Temp	7.32 (0.13)Aa	12.32 (0.15)Ab	15.88 (0.11)Ac
Leading Competitor	8.54 (0.21) Aa	7.54 (0.95)Ba	7.85 (0.77)Ba

Capital letters mean statistical difference between lines. Lowercase letters mean statistical differences between columns.

STRONGER ANTIMICROBIAL ACTIVITY

BC Temp has been shown to be effective against resistant bacteria such as E faecalis and S aureus at minimal inhibiting concentrations. Under the conditions of the study, a leading competitor did not show antimicrobial activity at the concentration tested.* While more studies are underway to compare BC Temp versus other Ca(OH)₂ materials, the manufacturer believes that BC Temp is more effective due to its unique calcium silicate, calcium oxide, and glycol salicylate formulation and the small particle size, which allows for more effective penetration versus conventional Ca(OH)₂.

LESS CYTOTOXIC WITH POTENTIAL FOR BETTER HEALING

BC Temp has been shown to be less cytotoxic compared to Ca(OH)₂. A recent study concluded that the tissue damage, initially caused by BC Temp (due to the high pH, which is normal and required for a intracanal dressings) is suppressed more quickly compared to those caused by the leading competitor, favoring the repair of connective tissue.*

BETTER COMPATIBILITY BETWEEN BC TEMP AND BIOCERAMIC SEALERS

Push-out tests showed that BC Temp did not influence the reduction of bond strength in teeth filled with bioceramic sealers. Multiple other studies have shown that Ca(OH)₂ reduces the bond strength of sealers when there are trace amounts left in the canal.*

IMPROVED HANDLING

BC Temp features a small particle size, so it exhibits optimal flow characteristics. Traditional Ca(OH)₂ can be gritty and may be difficult to deliver into the canal. According to our clinical evaluators, BC Temp flows smoothly from the 29-gauge precision tips provided and is easy to apply deep into the canal.

EASIER TO REMOVE

According to a recent study, BC Temp was easier to remove compared to a leading competitor under the conditions of all three of the removal methods. Three different removal methods utilized were a conventional syringe and needle, XP-3D irrigation, and ultrasonic irrigation.*

Microcomputed tomography analysis of percentage (%) of the volume of material removed (mm³) after the use of different intracanal medication removal techniques of BC Temp and a leading competitor

Removal Technique Used	BC Temp			Leading Competitor		
	CON	XP	US	CON	XP	US
% of Material Removal (mm ³)	86.90 ± 1.11	98.60 ± 1.39	94.70 ± 0.36	82.65 ± 2.43	94.54 ± 1.23	90.32 ± 1.34

CON = Conventional syringe and needle technique; XP = conventional technique associated with XP Endo Finisher Instrument; US = conventional technique associated with ultrasonic inserts

*Data on file.

EndoSequence® BC RRM™

EndoSequence® Root Repair Material (RRM™) is available in two specifically formulated consistencies (syringable paste or condensable putty) and contains many of the same characteristics as BC Sealer. The favorable handling properties, increased strength and shortened set time make RRM highly resistant to washout and ideal for all root repair and pulp capping procedures. Research and countless cases confirm that RRM is highly biocompatible and osteogenic.



SUPERIOR HANDLING

- ✓ Premixed-syringable paste or putty consistency
- ✓ Shortened Set Time (as short as 20 mins)
- ✓ Highly Resistant to Washout

EXCELLENT HEALING

- ✓ Highly Biocompatible
- ✓ Osteogenic
- ✓ Anti-bacterial (+12 pH)
- ✓ Non-Staining



EndoSequence® BC RRM™ Intro Syringe Kit:

- 1 1g Preloaded, Premixed Syringe
- 7 Intra-Canal Tips
- 1 Instructions for Use (IFU)
- 1 Safety Data Sheet (SDS)

Order No. 5018264U0



EndoSequence® BC RRM™ Bulk Syringe Kit:

- 2 1.5g Preloaded, Premixed Syringe
- 15 Intra-Canal Tips
- 1 Instructions for Use (IFU)
- 1 Safety Data Sheet (SDS)

Order No. 5018265U0



EndoSequence® BC RRM™ Putty:

- 1 3g Jar
- 1 Instructions for Use (IFU)
- 1 Safety Data Sheet (SDS)

Order No. 5018266U0



EndoSequence® BC RRM™ .5g Putty:

- 1 .5g Preloaded Syringe
- 1 Instructions for Use (IFU)
- 1 Safety Data Sheet (SDS)

Order No. 5026826U0



EndoSequence® BC RRM™ Fast-Set Putty:

- 1 .3g Preloaded Syringe
- 1 Instructions for Use (IFU)
- 1 Safety Data Sheet (SDS)

Order No. 5024200U0

Applications: Root Endo Filling (Retrograde fills), Repair of Root Perforation, Repair of Root Resorption, Apexification, Pulp Capping
 Composition: Calcium silicates, Calcium phosphate monobasic, Calcium hydroxide, Zirconium oxide, Tantalum oxide, Filler and thickening agents

BIOACTIVE

The following SEM images illustrate the similarities between MTA and RRM. “Group A” shows the crystalline surfaces of MTA and RRM. Both surfaces are composed primarily of calcium, carbon and oxygen. More notably, “Group B” shows the extent of human gingival fibroblast adhesion to MTA and RRM (after 7 days of incubation). Notice the extensive matrix-like overlay on the surface of the RRM. These SEMs visually confirm that RRM is highly bioactive and efficiently promotes biomineralization.

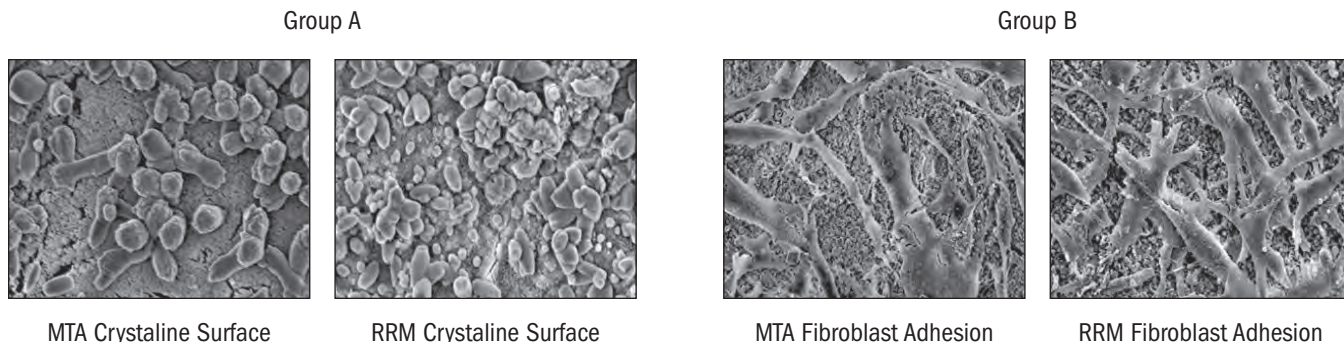

Source: Jingzhi M, Shen Y, Stojicic S, Haapasalo M. Biocompatibility of Two Novel Root Repair Materials. JOE. 2011; 37(6): 793-8

EXCELLENT BIOCOMPATIBILITY

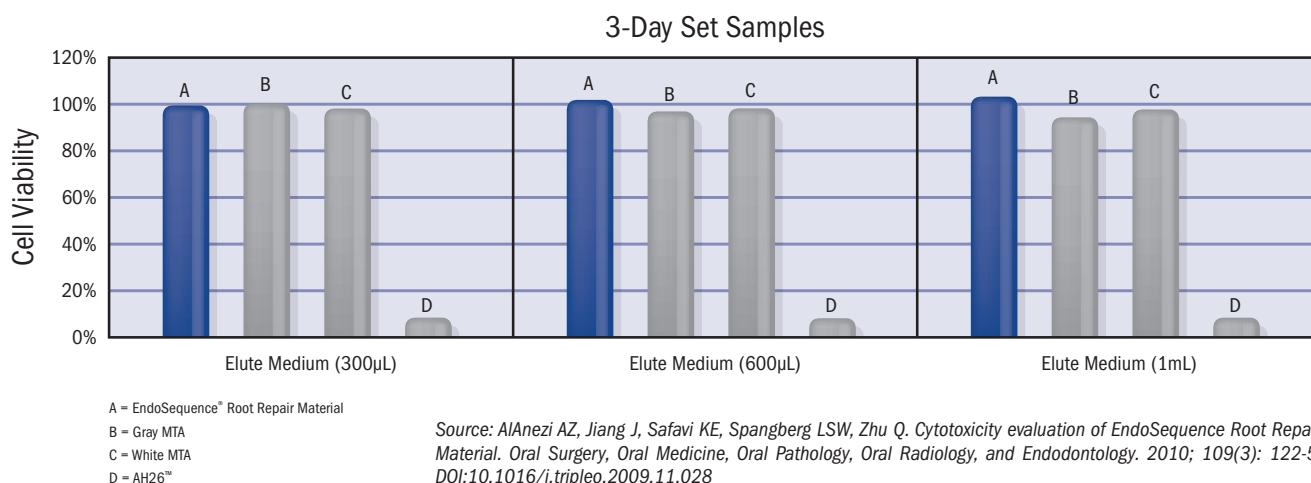

For a complete bibliography of all of the known published research on these materials please contact Brasseler USA or visit www.BrasselerUSA.com/bioceramics, which is dedicated to sharing information about these revolutionary materials.

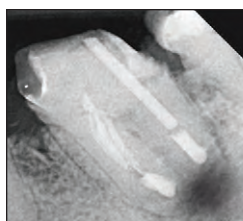

Immediate Post-Op Radiograph



6 Month Recall

“EndoSequence Root Repair Material's favorable properties, coupled with its ingenious moisture-initiated setting reaction and efficient clinical application, represents a step forward in root repair and surgical retrofilling materials.”

- Dr. Ali Nasseh
 Microsurgical Endodontics
 Boston, MA

Courtesy of Dr. Ali Nasseh, Microsurgical Endodontics, Boston, MA.

AH26™ is a trademark of Dentsply International.

EndoSequence BC Liner is Brasseler's latest innovation in the line of revolutionary EndoSequence BioCeramic Materials. Unlike BC Sealer™ and BC RRM™ (Root Repair Material), BC Liner is dual-cure and is designed to bridge the gap between pure calcium silicate based bioceramics and more user-friendly, light-curable bioactive restorative materials. EndoSequence BC Liner is a next-generation bioactive hybrid resin optimized for use with BC Sealer and BC RRM. This versatile and durable material chemically bonds to dentin without the need for a bonding agent. The unique, moisture-friendly chemistry seals teeth against bacterial leakage and continuously releases and recharges calcium, phosphate and fluoride ions for a lasting biological benefit.

STRONG, LASTING PROTECTION

BC Liner provides optimal protection for your root canal therapy. Not only is BC Liner bioactive; it is also extremely strong. Most Glass Ionomers or Resin Modified Glass Ionomers have a compressive strength of less than 150 MPa and a flexural strength of less than 40 MPa. BC Liner's novel formulation provides a compressive strength of 241 MPa and a flexural strength of 99.2 MPa*.



Available in Blue for Oriface Barriers!



BPA FREE!

Clinical Indications

- Base & Liner used over canals obturated with BC Sealer
- Base & Liner used over canals repaired with BC RRM

Physical Properties

Compressive Strength:	241 MPa
Flexural strength:	14,388 psi / 99.2 MPa
Deflection at break:	1.3 mm
Setting/curing time at 37°C (99°F):	90 seconds
Setting/curing time at 20°C (69°F):	200 seconds
Depth of cure at 5 seconds light curing:	1.91 mm
Depth of cure at 20 seconds light curing:	2.45 mm

*Internal testing following ISO 4049.

Clinical photograph courtesy of Allen Ali Nasseh, DDS, MMSc

LASTING PROTECTION AGAINST CORONAL LEAKAGE

Currently most endodontists utilize cotton and Cavit™ to cover their obturated canals. It is widely known that these materials provide virtually no protection from the bacteria-laden oral cavity. It is our mission to advance the standard of care by introducing this user-friendly, cost-effective solution for sealing the orifices of obturated root canals. Furthermore, EndoSequence BC Liner also provides an important function by protecting BC RRM (and ultimately the final restoration) after a repair or pulp capping procedure is performed. Up to this point, clinicians have had to use weaker, less biocompatible and less bioactive materials for this function. Unlike other RMGICs, EndoSequence BC Liner does not contain Bisphenol A, Bis-GMA or BPA derivatives.

BC Liner is provided with 40 BC Liner Short Tips. As with all automix materials it is advised to bleed out a small amount of material from each side of the syringe prior to placing the mixing tip. BC Liner is priced very reasonably to account for this small amount of waste.

EndoSequence® BC Liner™:

- 1 BC Liner
- 40 BC Liner Short Tips
- 1 Safety Data Sheet (SDS)

Order No. 5027169U0

EndoSequence® BC Liner™ Blue:

- 1 BC Liner Blue
- 40 BC Liner Short Tips
- 1 Safety Data Sheet (SDS)

Order No. 5027706U0



BC Liner™ Short Tips (40/Pack)

BC Liner Short Tips are ideal for covering root canal orifices with a thin layer material. These tips are provided with each box of BC Liner and are sold separately. The shorter mixing tip and narrow cannula minimize waste.



Order No. 5027158U0

BC Liner™ Long Tips (20/Pack)

BC Liner Long Tips provide for a more homogeneous mixture and are ideal for larger backfills. The wider cannula allows for easy dispensing. These tips are only sold separately.



Order No. 5027159U0

Cavit™ is a trademark of 3M.

EndoSequence® Core Build-Up Material + (CBM+™)

EndoSequence Core Build-Up Material + is a multi-purpose build-up and post cementation material that features an ideal balanced viscosity. This highly radiopaque, fluoride-releasing, dual-cure material has outstanding strength and is syringeable, while also being stackable. Unlike other core materials, there is virtually no perceivable difference between cutting EndoSequence CBM+ and natural dentin. The unique moisture-tolerant chemistry has self-adhesive and self-etching properties, which make bonding agents optional when there is a retentive form preparation. Unlike other core build-up materials, EndoSequence CBM+ does not contain Bisphenol A, Bis-GMA or BPA derivatives.

BASE/LINER & CORE BUILD-UP MATERIAL

Clinical Indications	Physical Properties
<ul style="list-style-type: none"> · Vital tooth build-up for crown prep · Core build-up after endo · Post cementation · Direct bonded core (intraradicular core build-up without a post) · Base/liner under restorations 	<p>Compressive strength: 44,080 psi / 304 MPa</p> <p>Flexural strength: 14,065 psi / 97 MPa</p> <p>Setting/curing time at 37°C (99°F): 3:15 minutes</p> <p>Light-cure setting time: 20 seconds</p> <p>Depth of cure: 4mm</p>



CBM+™ Dispensing Gun

Order No. 5027164U0

EndoSequence Core Build-Up Material +:

- 1 ES CBM+ Cartridge
- 30 ES CBM+ Automix Tips
- 30 ES CBM+ Delivery Tips
- 1 Safety Data Sheet (SDS)

Order No. 5027170U0



CBM+™ Automix Tips (30/Pack)

Order No. 5027161U0

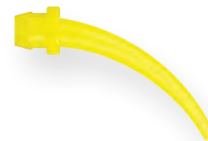

CBM+™ Delivery Tips (30/Pack)

Order No. 5027162U0

EndoSequence® Post System

EndoSequence can be likened to a prefabricated cast post because the shape/preparation created by your EndoSequence file also serves as your post space. There is no need to alter the shape of the canal with a post drill which can cause unwanted stress on the tooth.

EndoSequence posts are white and translucent, making them ideal for highly esthetic restorations. Each post is factory silanated to facilitate optimal bonding and they are highly radiopaque.

EndoSequence posts are extremely strong and have a modulus of elasticity similar to that of dentin which results in less stress on the tooth.

Features:

- High Zirconia content (68%) gives increased strength
- Low modulus of elasticity (49GPa) promotes natural movement of surrounding tooth structure
- Factory silanation ensures proper chemical and micro-mechanical bonding for dual and light cure resins
- High radiopacity for clear post-op radiographs
- White composite fiber composition ideal for highly esthetic restorations

Technique:

- Simply burnout the necessary amount of gutta percha or pre-cut the cone to create the desired apical plug.

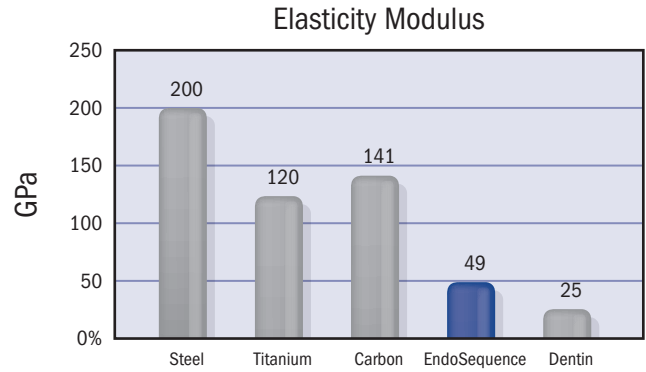

POST SYSTEMS

EndoSequence Post General Selection Guidelines

EndoSequence File/ Post Drill (.04 Taper)	EndoSequence Post to be Used (.04 Taper)	EndoSequence File/ Post Drill (.06 Taper)	EndoSequence Post to be Used (.06 Taper)
Tip Size 30	Tip Size .50	Tip Size 30	Tip Size .50
Tip Size 50	Tip Size .70	Tip Size 50	Tip Size .70
Tip Size 70 (.04 Taper Only)	Tip Size .90	Tip Size 50 (Work Circumpherically to Expand)	Tip Size .90
Tip Size 80 (.04 Taper Only)	Tip Size 1.1	Tip Size 50 (Work Circumpherically to Expand)	Tip Size 1.0

EndoSequence Posts (5/Pack)

Tip ID	Tip Size	.04 Taper	.06 Taper
Yellow	.50	5013508U0	5013512U0
Red	.70	5013509U0	5013513U0
Blue	.90	5013510U0	5013514U0
Green	1.0	-	5013515U0
Green	1.1	5013511U0	-



K0165 EndoSequence® Post Starter Kit (.04 Taper):

- 5 ea. (sizes .50-1.1) EndoSequence Posts (.04 Taper)
- 1 Universal Finishing Diamond
- 1 Hand Driver
- 1 Instructions for Use (IFU)

Order No. 5015623U0

K0166 EndoSequence® Post Starter Kit (.06 Taper):

- 5 ea. (sizes .50-1.0) EndoSequence Posts (.06 Taper)
- 1 Universal Finishing Diamond
- 1 Hand Driver
- 1 Instructions for Use (IFU)

Order No. 5015624U0

DentFlex™ Post System

DentFlex Posts are composed of the same material as EndoSequence Posts, but utilize a post drill and are parallel except for the tip.

- High Zirconia content (68%) gives increased strength
- Low modulus of elasticity (49GPa) promotes natural movement of surrounding tooth structure
- Factory silanation ensures proper chemical and micro-mechanical bonding for dual and light cure resins
- High radiopacity for clear post-op radiographs
- White composite fiber composition ideal for highly esthetic restorations
- Matching drills to facilitate ideal placement

Elasticity Modulus

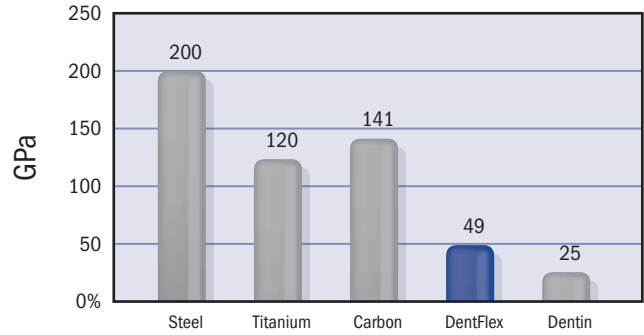

DentFlex Posts (10/Pack)

Tip ID	Tip Size	3° Taper
○ White	1.0	5013913U0
● Yellow	1.2	5013914U0
● Red	1.4	5013915U0
● Blue	1.6	5013916U0



DentFlex Drills (1/Pack)

Tip ID	Tip Size	3° Taper
○ White	1.0	5013917U0
● Yellow	1.2	5013918U0
● Red	1.4	5013919U0
● Blue	1.6	5013920U0

DentFlex Kits

DF110 DentFlex Refill Kit:

10	1.0 mm DentFlex Posts
1	1.0 mm DentFlex Drill

Order No. 5013909U0

DF120 DentFlex Refill Kit:

10	1.2 mm DentFlex Posts
1	1.2 mm DentFlex Drill

Order No. 5013910U0

DF140 DentFlex Refill Kit:

10	1.4 mm DentFlex Posts
1	1.4 mm DentFlex Drill

Order No. 5013911U0

DF160 DentFlex Refill Kit:

10	1.6 mm DentFlex Posts
1	1.6 mm DentFlex Drill

Order No. 5013912U0



DF100 DentFlex Introductory Kit:

5	1.0 mm DentFlex Posts
5	1.2 mm DentFlex Posts
5	1.4 mm DentFlex Posts
5	1.6 mm DentFlex Posts
1	1.0 mm DentFlex Drill
1	1.2 mm DentFlex Drill
1	1.4 mm DentFlex Drill
1	1.6 mm DentFlex Drill

Order No. 5013908U0



















Vlock™ & Vario™ Titanium Post Systems

- Color coded identification system matches the correct drill, root facer and wrench to each post
- Unique drill design creates the optimal parallel post preparation without the need for gates or peeso reamers
- Vlock posts feature a unique tapered head design which provides optimal surface area for mechanical retention of core material
- Vlock and Vario Active Posts feature a threaded design for maximum retention
- Vlock Passive Posts feature retention grooves and are recommended for brittle teeth
- Posts are manufactured of high quality pure titanium
- Post accessories are manufactured of high quality stainless steel and are highly resistant to corrosion from sterilization









Vlock Post System

For cases when sufficient space for a post head is available.

	 Vlock™ Active Posts						 Vlock™ Passive Posts					
Length	Standard			Long			Standard			Long		
Size	1	2	3	1	2	3	1	2	3	1	2	3
Color												
Order Number	T63L6.1	T63L7.2	T63L9.3	T51L13.1	T52L13.2	T53L13.3	T64L6.1	T64L7.2	T64L9.3	T54L13.1	T55L13.2	T56L13.3
Shank Dia. D (mm)	1.30	1.50	1.75	1.30	1.50	1.75	1.15	1.35	1.60	1.15	1.35	1.60
Shank Dia. L (mm)	6.0	7.0	9.0	13.0	13.0	13.0	6.0	7.0	9.0	13.0	13.0	13.0
Head Dia. D (mm)	2.5	3.0	4.0	2.5	3.0	4.0	2.5	3.0	4.0	2.5	3.0	4.0
Head Length L (mm)	2.75	3.85	4.90	2.75	3.85	4.90	2.75	3.85	4.90	2.75	3.85	4.90
	116.21.1	116.21.2	116.21.3	116.21.1	116.21.2	116.21.3	116.21.1	116.21.2	116.21.3	116.21.1	116.21.2	116.21.3
	1791.21.012	1792.21.014	1793.21.016	1791.21.012	1792.21.014	1793.21.016	1791.21.012	1792.21.014	1793.21.016	1791.21.012	1792.21.014	1793.21.016
Wrenches	66L6	66L7	66L9	66L6	66L7	66L9	66L6	66L7	66L9	66L6	66L7	66L9
Kits*	4118	4119	4120	4123	4124	4125	4128	4129	4130	4133	4134	4135
Combo Kits**	4122			4127			4132			4137		

Vario Post System

For cases when insufficient space for a post head is available.

	 Vario™ Active Posts					
Length	Standard			Long		
Size	1	2	3	1	2	3
Color						
Order Number	T91L6.1	T92L7.2	T93L9.3	T91L13.1	T92L13.2	T93L13.3
Shank Dia. D (mm)	1.30	1.50	1.75	1.30	1.50	1.75
Shank Dia. L (mm)	6.0	7.0	9.0	13.0	13.0	13.0
Head Dia. D (mm)	1.30	1.50	1.75	1.30	1.50	1.75
Head Length L (mm)	3.50	3.50	3.50	3.50	3.50	3.50
	1791.21.012	1792.21.014	1793.21.016	1791.21.012	1792.21.014	1793.21.016
Wrenches	127.1	127.2	127.3	127.1	127.2	127.3
Kits*	-	-	-	4191	4192	4193
Combo Kits**	-			4190		

*Includes 10 posts, 1 drill, 1 wrench

**Includes 15 posts (5 of each), 3 drills (1 of each), 3 wrenches (1 of each)

EndoSync™ Plus

The dynamic design of the EndoSync Plus Cordless offers the market's only torque controlled, open-platform software that allows for complete customization of motion; an unprecedented feature in the industry. This high performance endodontic micromotor is the lightest cordless handpiece in its class with numerous safety features, including: Optimized Torque Reverse (OTR) technology, torque slowdown, and highly intuitive apical actions when connected to the EndoSync A.I. Apex locator. The EndoSync Cordless offers the safety you deserve with the efficiency you require.

POWER SYSTEMS



EndoSync Plus

Set Includes Motor, Head, Charging Base

Weight: 100 grams

6 Memory Settings

Programmable Motions

Speed Range: 50-1,000 rpm

Rechargeable Lithium Ion Batteries

1-Year Warranty

Order No. 5027135U0

ESR CM ENDOSEQUENCE™
RECIPROCATING FILE



Designed to be used with Brasseler
ESR CM files and all rotary and
reciprocating NiTi systems

EndoSync™ A.I.

The EndoSync A.I. Apex Locator features the latest innovative design and technology in endodontic measurements, all encompassed in a lightweight, compact system. Equipped with automatic calibration, a memory bar, audible warnings, and a large LCD screen, the EndoSync A.I. delivers precision to meet your endodontic needs.

EndoSync A.I.

Weight: 110 grams
Size (mm): 60 (w) × 103 (d) × 57 (h)
Battery: DC 1.5V AAA
3 Memory Settings
1-Year Warranty

Order No. 5025412U0



EndoSync Transmission Cable

- Required to connect EndoSync Cordless to EndoSync A.I.

Order No. 5025552U0

SIMPLE

The lightweight, compact and portable design features an easy-to-operate panel with three memory settings.

SAFE

With the latest technology in endodontic measurements, the EndoSync A.I. accurately determines the file's location in a variety of canal conditions. The accuracy is unaffected by the presence of blood, electrolytes, saline or irrigants in the canal.

SMART

Automatically calibrates to meet canal conditions during treatment including changes to temperature and moisture with the ability to work in synchronization with the EndoSync Cordless.

EndoSequence® 2

SAFE. PREDICTABLE. PRECISE.

The portable EndoSequence 2 and EndoDrive Plus endodontic micromotors from Brassler USA are versatile platforms for successful root canal treatment. The lightweight EndoDrive Plus offers an easy-to-read LCD screen while the EndoSequence 2 provides the flexibility of a cordless device. Both systems feature a miniature head for excellent visibility during procedures and the safety and comfort that comes with torque control and auto reverse.

EndoSequence® 2 Complete Set

Set Includes Motor, Head, Charging Base
5 Programmable Settings
Auto Reverse
Torque Control
Speed Range: 200-1,000 rpm
AAA Rechargeable Batteries
1-Year Warranty

Order No. 5021327U0



EndoDrive Plus™

EndoDrive Plus Complete Set

Set Includes Motor, Head, Control Unit and AC Adapter
9 Programmable Settings
Auto Reverse
Torque Control
Speed Range: 100-650 rpm
1-Year Warranty

Order No. 5021328U0



EndoPro 270™

A NEW GENERATION OF ENDODONTIC TECHNOLOGY

The EndoPro 270 powered heat source from Brasseler USA ushers in a new generation of technology for successful root canal treatments. The EndoPro 270 is the most advanced power heat source on the market with a remarkable ergonomic design. The advanced powered heat source of the EndoPro 270 delivers the superior benefits required in your practice.



POWER SYSTEMS



EndoPro 270 Complete Set

- Set Includes Handpiece, Charging Base, and Heated Plugger
- 4 Hours of Continual Use With Single Charge
- Weight: 63 g
- 6 Temperature Settings up to 270°C
- 1-Year Warranty

Order No. 5019927U0

EndoPro 270 Pluggers



Description	SML (45/04)	MED (55/08)	LRG (60/12)	SML/MED (55/06)
Order No.	5019928U0	5019929U0	5019930U0	5019931U0



Description	MED/LRG (55/10)	Thin Spreader	Vitality Testing Tip
Order No.	5019932U0	5019933U0	5019934U0

ELEGANT AND INTUITIVE

The slim, ergonomic design of the Forza V3 handpiece provides excellent access while the LED illumination from dual fiber optics delivers clearer vision and maximum visibility. With a wide range of piezo ultrasonic tips available, the Forza V3 is ideal for a variety of clinical procedures including general scaling, perio and endo.



ULTRASONICS



Forza V3 LED Complete Set

Set includes Control Unit, Handpiece, Control Unit Holder, Water Filter and Connector Set, Foot Control, Tip Wrench, AC Adapter, Three Scaling Tips (G1, G9, G11) LED Fiber Optic
General, Perio & Endo Modes
Easy Power & Water Adjustment
Piezo Accelerator Mode

Order No. 5023152U0













































Forza V3 Non-Optic Complete Set

Set includes Control Unit, Handpiece, Control Unit Holder, Water Filter and Connector Set, Foot Control, Tip Wrench, AC Adapter, Three Scaling Tips (G1, G9, G11) Non-Fiber Optic
General, Perio & Endo Modes
Easy Power & Water Adjustment
Piezo Accelerator Mode

Order No. 5023153U0















Ultrasonic Tips

Endo



E4	5011379U0				<ul style="list-style-type: none"> • Water cooled • For root canal cleaning
E4D	5025641U0				<ul style="list-style-type: none"> • Water cooled • Diamond coated • Non-coated tip • For root canal cleaning
E5	5010233U0				<ul style="list-style-type: none"> • Lateral condensation
E6	5010234U0				<ul style="list-style-type: none"> • Lateral condensation
E7	5010235U0				<ul style="list-style-type: none"> • Removal of filling and foreign material
E7D	5025642U0				<ul style="list-style-type: none"> • Water cooled • Diamond coated • Enlargement of root canal wall
E8	5010236U0				<ul style="list-style-type: none"> • Removal of filling and foreign material
E8D	5025643U0				<ul style="list-style-type: none"> • Water cooled • Diamond coated • Enlargement of root canal wall
E9	5012561U0				<ul style="list-style-type: none"> • Water cooled • Removal of filling and foreign material
E9D	5025644U0				<ul style="list-style-type: none"> • Water cooled • Diamond coated • Troughing • Access refinement
E14D	5025645U0				<ul style="list-style-type: none"> • Water cooled • Diamond coated • Enlargement of root canal wall
E15	5019426U0				<ul style="list-style-type: none"> • Water cooled • Post removal
E15D	5026546U0				<ul style="list-style-type: none"> • Water cooled • Diamond coated • Pulp stone removal • Troughing
E16D	5019427U0				<ul style="list-style-type: none"> • Water cooled • Diamond coated • Troughing • Access refinement
E17D	5019428U0				<ul style="list-style-type: none"> • Ditching and posts • Paste removal • Chasing calcified canals • Instrument removal









Ultrasonic Tips

Endo

E18D	5019429U0				<ul style="list-style-type: none"> · Ditching and posts · Paste removal · Chasing calcified canals · Instrument removal
E19D	5019430U0				<ul style="list-style-type: none"> · Ditching and posts · Paste removal · Chasing calcified canals · Instrument removal
E20	5019431U0				<ul style="list-style-type: none"> · Titanium alloy · Instrument removal
E21	5019432U0				<ul style="list-style-type: none"> · Titanium alloy · Instrument removal
E22	5019433U0				<ul style="list-style-type: none"> · Titanium alloy · Instrument removal

Endodontic V-Tip



















V30	5010251U0			V-Tip Holder
-----	-----------	------------------------------------------------------------------------------------	-------------------------------------------------------------------------------------	--------------

VS50	5013303U0		<ul style="list-style-type: none"> · For root canal cleaning (17 mm) · Pack of 3
VS51	5013304U0		<ul style="list-style-type: none"> · For root canal cleaning (23 mm) · Pack of 3
VS52	5013305U0		<ul style="list-style-type: none"> · For root canal cleaning (26 mm) · Pack of 3
VS53	5013306U0		<ul style="list-style-type: none"> · For root canal cleaning (32 mm) · Pack of 3
VS50D	5025651U0		<ul style="list-style-type: none"> · Diamond coated · For root canal enlargement (17 mm) · Pack of 3
VS51D	5025652U0		<ul style="list-style-type: none"> · Diamond coated · For root canal enlargement (23 mm) · Pack of 3
VS52D	5025653U0		<ul style="list-style-type: none"> · Diamond coated · For root canal enlargement (26 mm) · Pack of 3
VS53D	5025654U0		<ul style="list-style-type: none"> · Diamond coated · For root canal enlargement (32 mm) · Pack of 3













Each pack of V30 includes one (1) E Tip replacement wrench. Replacement wrench is not included when ordering other tips. Please order the replacement wrench separately in this instance.

Ultrasonic Tips

Retrograde Endo - Standard Length (BEST - Brasseler Endo Surgery Tips)

BEST 1D	5019434U0				<ul style="list-style-type: none"> • Diamond coated • For anterior teeth (see chart)
BEST 2D	5019435U0				<ul style="list-style-type: none"> • Diamond coated • For anterior teeth (see chart)
BEST 3D	5019436U0				<ul style="list-style-type: none"> • Diamond coated • For posterior teeth (see chart)
BEST 4D	5019437U0				<ul style="list-style-type: none"> • Diamond coated • For posterior teeth (see chart)
BEST 5D	5019438U0				<ul style="list-style-type: none"> • Diamond coated • For posterior teeth (see chart)
BEST 6D	5019439U0				<ul style="list-style-type: none"> • Diamond coated • For posterior teeth (see chart)

Retrograde Endo - Shorter Length

E30RD	5025647U0				<ul style="list-style-type: none"> • Diamond coated • For posterior teeth (right angled)
E30LD	5025648U0				<ul style="list-style-type: none"> • Diamond coated • For posterior teeth (left angled)
E31D	5025649U0				<ul style="list-style-type: none"> • Diamond coated • For anterior and posterior teeth (70°)
E32D	5025650U0				<ul style="list-style-type: none"> • Diamond coated • For anterior teeth (90°)





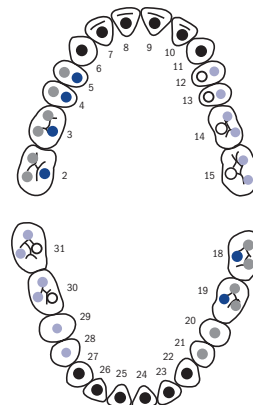

Working Zones





Tip No.	Teeth No.
BEST 1D & 2D	● 6-11 & 22-27
BEST 3D	● 2-5 & 16-21
BEST 4D	● 2-5 & 18-19
BEST 5D	● 12-15 & 28-31
BEST 6D	○ 12-15 & 30-31



Ultrasonic Tips

U Files

E11	5010249U0				<ul style="list-style-type: none"> For U files (shank dia: 0.8 mm) For root canal cleaning For anterior teeth
E12	5010250U0				<ul style="list-style-type: none"> For U files (shank dia: 0.8 mm) For root canal cleaning For posterior teeth

U Files #15	5010198U0		<ul style="list-style-type: none"> Pack of 6 ISO15
U Files #20	5010199U0		<ul style="list-style-type: none"> Pack of 6 ISO20
U Files #25	5010200U0		<ul style="list-style-type: none"> Pack of 6 ISO25
U Files #30	5010201U0		<ul style="list-style-type: none"> Pack of 6 ISO30
U Files #35	5010202U0		<ul style="list-style-type: none"> Pack of 6 ISO35

Each pack of E11 or E12 includes one (1) ETip replacement wrench. Replacement wrench is not included when ordering other tips. Please order the replacement wrench separately in this instance.

Application	Tip Code	Application	Tip Code
Access Refinement	E9D, E14D, E16D	Broken Instrument Removal	E20-E22
Troughing for Orifices	E9D, E14D, E15D, E16D	Core/Restorative Material Removal	E9D, E15, E15D, E16D, E17D
Pulp Stone Removal	E15D, E16D, E17D	Chasing Calcified Canals	E17D-E19D
Post Removal	E4, E9, E15	Canal Shaping	E11/E12 with U Files
Obturation Material Removal	E17D-E22	Acoustic Streaming	All Non-Diamond Coated Tips & U Files

Ultrasonic Tip Kit



K0209 Ultrasonic Tip Kit:

- 1 E4 Tip
- 1 E9 Tip
- 1 E9D Tip
- 1 E14D Tip
- 1 E15D Tip
- 1 A641 Black Aluminum Tip Caddy

Order No. 5025741U0

A641 Ultrasonic Tip Caddy



Order No. 5019698U0

CR-10 Torque Limiting Wrench



Order No. 5019770U0

CR-2 Standard Tip Wrench



Order No. 5019700U0

Power Settings: For all ultrasonic tips the practitioner should start at the lowest power setting on their unit and incrementally increase the power if needed. Long and narrow tips should always be used at the lowest functional power setting.

Water Spray: All Brasseler Endo Ultrasonic tips contain water ports which are designed to keep the tip cool during use. Most specialists do not condone the use of non-water cooled tips for endodontic applications.

Hand Instruments

Crown Removers & Spreaders

· Used to remove permanent and temporary crowns.



240097K00

Kline Crown Remover for bicuspid and molar crowns

Order No. 5001266U0



B134

Crown Spreader
Three surfaces set at different angles for easy adaptation for crown removal

#4 Handle 5023314U0

#6 Handle 5023315U0



EB134

Crown Spreader · Elite Handle
Three surfaces set at different angles for easy adaptation for crown removal

Order No. 5023316U0



CRZ

Crown Spreader · Also known as ZENA

Order No. 5023313U0

Endo Grooved Pliers

· Endo Pliers have horizontal and vertical grooves to align and hold fine gutta percha points during endodontic procedures.



300

Locking Endo Plier

Order No. 5001865U0



300NL





Non-Locking Endo Plier

Order No. 5008928U0

Hand Instruments





Explorers - Double End

· Endodontic explorers are designed with longer working ends and are used to locate canal orifices.

 <p>70°</p> <p>EXEDG16</p> <p>45°</p>	<table border="0"> <tr><td>#2 Handle</td><td>5023540U0</td></tr> <tr><td>#4 Handle</td><td>5023546U0</td></tr> <tr><td>#6 Handle</td><td>5023549U0</td></tr> </table>	#2 Handle	5023540U0	#4 Handle	5023546U0	#6 Handle	5023549U0
#2 Handle	5023540U0						
#4 Handle	5023546U0						
#6 Handle	5023549U0						
 <p>70°</p> <p>EXEDG16/16</p> <p>70°</p>	<table border="0"> <tr><td>#2 Handle</td><td>5023541U0</td></tr> <tr><td>#4 Handle</td><td>5023547U0</td></tr> <tr><td>#6 Handle</td><td>5023548U0</td></tr> </table>	#2 Handle	5023541U0	#4 Handle	5023547U0	#6 Handle	5023548U0
#2 Handle	5023541U0						
#4 Handle	5023547U0						
#6 Handle	5023548U0						
 <p>70°</p> <p>EXEDG16/17</p>	<table border="0"> <tr><td>#2 Handle</td><td>5023542U0</td></tr> <tr><td>#6 Handle</td><td>5023543U0</td></tr> </table>	#2 Handle	5023542U0	#6 Handle	5023543U0		
#2 Handle	5023542U0						
#6 Handle	5023543U0						
 <p>70°</p> <p>EXEDG16/23</p>	<table border="0"> <tr><td>#2 Handle</td><td>5023544U0</td></tr> <tr><td>#6 Handle</td><td>5023545U0</td></tr> </table>	#2 Handle	5023544U0	#6 Handle	5023545U0		
#2 Handle	5023544U0						
#6 Handle	5023545U0						

Excavators

· Endodontic excavators have long shank spoons for dentin removal from the base of the pulp chamber.

 <p>1.2 mm</p> <p>EXCE31L</p> <p>Long extended shank</p>	<table border="0"> <tr><td>#2 Handle</td><td>5023531U0</td></tr> <tr><td>#6 Handle</td><td>5023532U0</td></tr> </table>	#2 Handle	5023531U0	#6 Handle	5023532U0		
#2 Handle	5023531U0						
#6 Handle	5023532U0						
 <p>1.5 mm</p> <p>EXCE32L</p> <p>Long extended shank</p>	<table border="0"> <tr><td>#2 Handle</td><td>5023534U0</td></tr> <tr><td>#4 Handle</td><td>5023535U0</td></tr> <tr><td>#6 Handle</td><td>5023536U0</td></tr> </table>	#2 Handle	5023534U0	#4 Handle	5023535U0	#6 Handle	5023536U0
#2 Handle	5023534U0						
#4 Handle	5023535U0						
#6 Handle	5023536U0						
 <p>1.5 mm</p> <p>EXCE31W</p> <p>Long extended shank</p>	<table border="0"> <tr><td>#6 Handle</td><td>5023533U0</td></tr> </table>	#6 Handle	5023533U0				
#6 Handle	5023533U0						
 <p>2.0 mm</p> <p>EXCE33L</p> <p>Long extended shank</p>	<table border="0"> <tr><td>#2 Handle</td><td>5023537U0</td></tr> <tr><td>#4 Handle</td><td>5023538U0</td></tr> <tr><td>#6 Handle</td><td>5023539U0</td></tr> </table>	#2 Handle	5023537U0	#4 Handle	5023538U0	#6 Handle	5023539U0
#2 Handle	5023537U0						
#4 Handle	5023538U0						
#6 Handle	5023539U0						

Hand Instruments

Pluggers - Single End

- Endodontic Pluggers are used to condense filling material vertically.
- Pluggers have marking at 5mm intervals.



#6 Handle 5026158U0



#6 Handle 5026159U0



#6 Handle 5026160U0

Pluggers - Double End

- Endodontic Pluggers are used to condense filling material vertically.
- Pluggers have marking at 5mm intervals.



#2 Handle 5023552U0
 #4 Handle 5023553U0
 #6 Handle 5023554U0



#4 Handle 5023550U0





#4 Handle 5023551U0

Hand Instruments

Stainless Steel Spreaders · Single End

· Endodontic spreaders are used to compact filling material laterally.

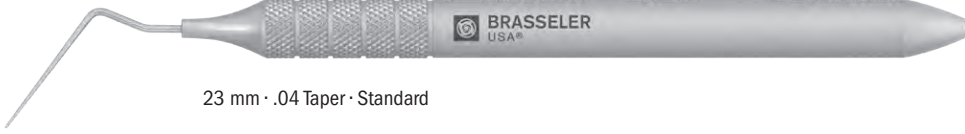



HAND INSTRUMENTS

SED11		#2 Handle	5023558U0
		#6 Handle	5023560U0
23 mm · .04 Taper · Standard			
SED11T		#2 Handle	5023561U0
		#6 Handle	5023563U0
21 mm · .04 Taper · Thin			
SED11TS		#6 Handle	5026163U0
21 mm · .04 Taper · Thinnest			

Nickel Titanium Spreaders · Single End

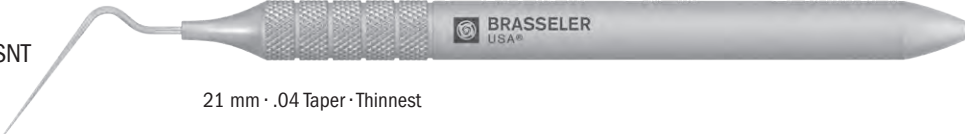
· Endodontic spreaders are used to compact filling material laterally.

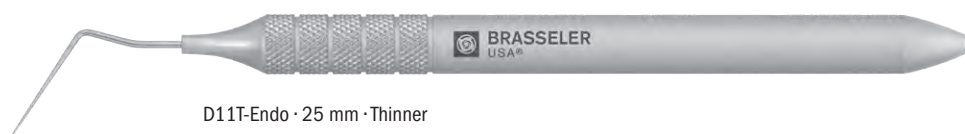
· NaviFlexNT[®] nickel titanium hand spreaders provide greater flexibility and extra strength.

SED11TSNT		#6 Handle	5026164U0
21 mm · .04 Taper · Thinnest			
NTD11T		#2 Handle	5007773U0
		#4 Handle	5009518U0
		#6 Handle	5009752U0
D11T-Endo · 21 mm · Thinner			
SE25NT		#6 Handle	5026166U0
D11T-Endo · 25 mm · Thinner			
SEMA57NT		#6 Handle	5026165U0
MA5728 · Spreader · 28 mm			
NT4SP		#2 Handle	5007776U0
		#4 Handle	5009521U0
Spreader · 21 mm			

Hand Instruments

Stieglitz



ST45

Bent at 45° · Stainless steel micro forceps for removing obstructions or debris from the root canal · Serrated tips - 5 ¼ in

Order No. 5023705U0

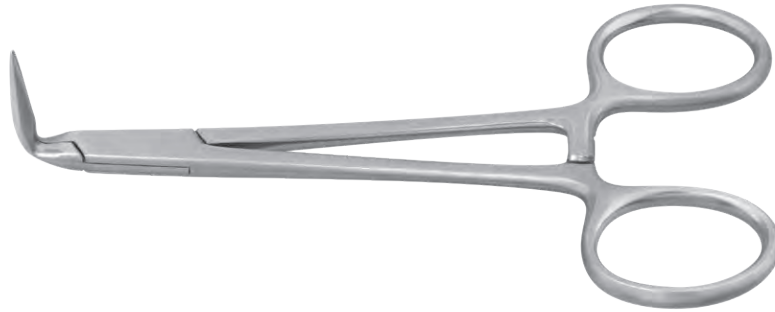

ST90

Bent at 90° · Stainless steel micro forceps for removing obstructions or debris from the root canal · Serrated tips - 4 ¾ in

Order No. 5023706U0

Castroviejo



Order No. 5024824U0

Micro Steiglitz Forceps · 45°

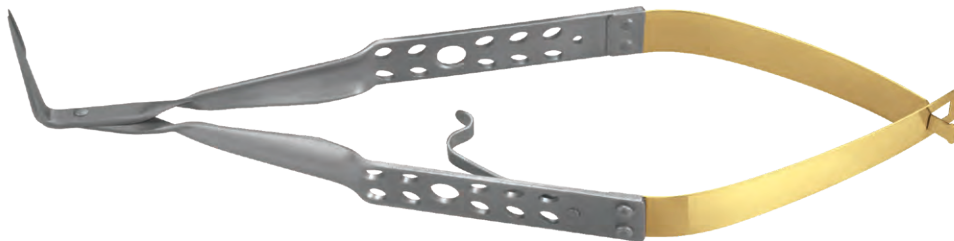

Order No. 5024825U0

Micro Steiglitz Forceps · 90°

Endo Black™ Premium Instruments

Endo Black instruments are lightweight, ideally balanced and feature a unique knurled handle for precision dexterity. The tips feature an exclusive, anti-reflective DLC (diamond-like carbon) coating, which improves cutting edge fidelity and inhibits reflective light, which is a common issue under high magnification.



Dressing Forceps

Order No. 5026961U0

Mirror Handles and Mirrors



Mirror Handle - Double End
Simple Stem/European Style

Order No. 5026962U0



Mirror Handle - Single End
Simple Stem/European Style

Order No. 5026969U0



Mirror Face (12/Pack)
Simple Stem/European Style
#4 7/8 Inch Diameter

Order No. 5026970U0



Round Micro Mirror (.5 mm)

Order No. 5026963U0



Oval Micro Mirror (3 x 6 mm)

Order No. 5026964U0

Endo Black™ Premium Instruments



Micro Blade Mirror Holder 7 mm

Order No. 5028592U0



Micro Mirror 2 mm SS Flex

Order No. 5028589U0



Micro Mirror 3 mm SS Flex

Order No. 5028590U0



Micro Mirror 4 mm SS Flex

Order No. 5028591U0

Endo Black Surgical System



Explorer DG16

Order No. 5026968U0



SG13/14 Mini Gracey Curette

Order No. 5026952U0

Endo Black™ Premium Instruments



SC13/14 Posterior Columbia Curette

Order No. 5026953U0



GTEXC1 Granulation Tissue Excavator

Order No. 5026954U0



GTEXC2 Granulation Tissue Excavator

Order No. 5026955U0



Ball Burnisher/Carver #2

Order No. 5026960U0



Prichard Periosteal Elevator

Order No. 5026966U0



PPR2/4 Periosteal Elevator, Sharp

Order No. 5026956U0

Endo Black™ Premium Instruments



PM9 Periosteal Elevator

Order No. 5026957U0



Micro Plugger .50 mm LR

Order No. 5026958U0



Micro Plugger .75 mm LR

Order No. 5026959U0



PLEMICRO1 Micro Plugger .6 mm LR

Order No. 5028588U0



PLEPR Perforation Repair Plugger

Order No. 5028587U0

Endo Black™ Premium Instruments

GPR (Gutta Percha Removal)



EGPR LR 30 mm

Order No. 5026971U0



EGPR UD 30 mm

Order No. 5026975U0



EGPR LR 18 mm

Order No. 5026976U0



EGPR UD 18mm

Order No. 5026977U0



ELES LR DC 18/30 mm
Diamond Coated

Order No. 5027004U0

Endo Black™ Premium Instruments



MTA Delivery/Carver

Order No. 5027030U0



MTA Block

Order No. 5026965U0

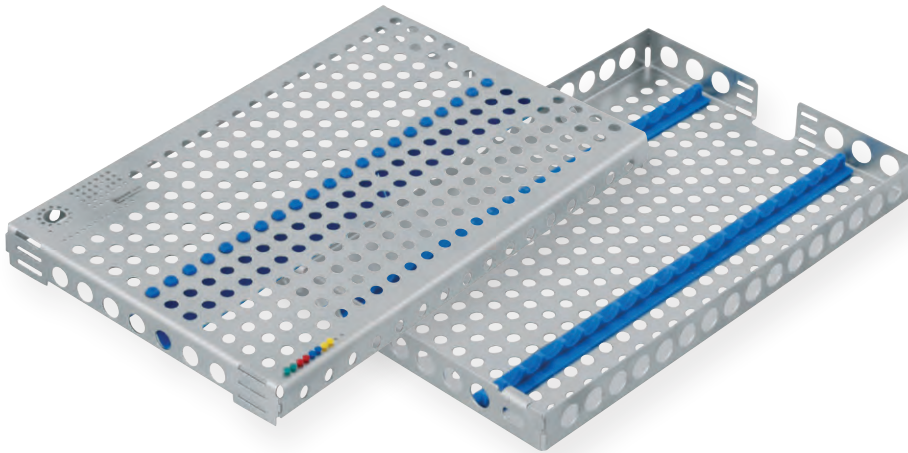

SINSTC Surgical Cassette with Lid
Adjustable to 3 Different Depths

Dimensions: 10 3/4 in x 7 in
Adjustable to 3 depths:

- 1 in
- 1 1/4 in
- 1 1/2 in

Order No. 5026967U0



K0336 XP-3D™ Intro Kit:

- 2 XP-3D Shaper RF30 25mm (3/pk)
- 1 XP-3D Shaper RF30 21mm (3/pk)
- 1 XP-3D Finisher R RF30 25mm (3/pk)
- 1 BC Points/Paper Points Asst Wheel .04 15-60
- 1 EndoSequence BC Sealer
- 1 XP-3D Chairside Guide

Order No. 5026130U0



K0338 XP-3D™ Starter Kit:

- 6 XP-3D Shaper RF30 25mm (3/pk)
- 10 XP-3D Shaper RF30 21mm (3/pk)
- 4 XP-3D Shaper RF30 31mm (3/pk)
- 4 XP-3D Finisher R RF30 25mm (3/pk)
- 4 XP-3D Finisher R RF30 21mm (3/pk)
- 2 ESX Scouting File 15 .04 21mm (3/pk)
- 2 ESX Scouting File 15 .04 25mm (3/pk)
- 1 ESX Scouting File 15 .02 25mm (3/pk)
- 1 ESX Orifice Shaper 20 .08 19mm (3/pk)
- 5 KontrolFlex Stiff K-File 08 25mm (6/pk)
- 5 KontrolFlex Stiff K-File 10 25 (6/pk)
- 5 KontrolFlex Stiff K-File 15 25 (6/pk)
- 1 BC Points/Paper Points Asst Wheel .04 15-60
- 1 EndoSequence Canal Clean (100mL)
- 1 EndoSequence Lubricant
- 1 EndoSequence BC Sealer
- 1 XP-3D Chairside Guide

Order No. 5026135U0



K0402 ESR™ CM Intro Kit:

- 3 ESR CM #20 25 mm (3/pk)
- 3 ESR CM #25 25 mm (3/pk)
- 3 ESR CM #30 25 mm (3/pk)
- 2 ESR CM #40 25 mm (3/pk)
- 2 ESR CM #50 25 mm (3/pk)
- 1 ESR CM Scout C #15 25 mm (3/pk)
- 1 BC GP .04 #20 (60/pk)
- 1 BC GP .06 #25 (60/pk)
- 1 BC GP .04 #30 (60/pk)
- 1 BC GP .04 #40 (60/pk)
- 1 BC GP .04 #50 (60/pk)
- 1 EndoSequence BC Sealer

Order No. 5028422U0



K0404 ESR™ CM Starter Kit:

- 9 ESR CM #20 25 mm (3/pk)
- 9 ESR CM #25 25 mm (3/pk)
- 9 ESR CM #30 25 mm (3/pk)
- 6 ESR CM #40 25 mm (3/pk)
- 6 ESR CM #50 25 mm (3/pk)
- 5 ESR CM #20 21 mm (3/pk)
- 5 ESR CM #25 21 mm (3/pk)
- 5 ESR CM #30 21 mm (3/pk)
- 5 ESR CM Scou C #15 25 mm (3/pk)
- 5 ESR CM Scout C #15 21 mm (3/pk)
- 1 BC GP .04 #20 (60/pk)
- 1 BC GP .06 #25 (60/pk)
- 1 BC GP .04 #30 (60/pk)
- 1 BC GP .04 #40 (60/pk)
- 1 BC GP .04 #50 (60/pk)
- 1 EndoSequence BC Sealer

Order No. 5028423U0



K0397 EndoSequence® Blend Intro Kit:

- 3 ES-CM #30 .04 25 mm (4/pk)
- 1 ES-CM #35 .04 25 mm (4/pk)
- 1 ES-CM #40 .04 25 mm (4/pk)
- 1 ES Scout #25 .04 25 mm (4/pk)
- 1 ES Scout #20 .04 25 mm (4/pk)
- 1 BC Obturation Kit .04 (BC Sealer + GP Wheel)

Order No. 5027689U0



K0398 EndoSequence® Blend Starter Kit:

- 8 ES-CM #30 .04 25 mm (4/pk)
- 5 ES-CM #35 .04 25 mm (4/pk)
- 4 ES-CM #40 .04 25 mm (4/pk)
- 5 ES Scout #25 .04 25 mm (4/pk)
- 5 ES Scout #20 .04 25 mm (4/pk)
- 2 ES #20 .08 16mm (4/pk)
- 5 KontrolFlex Stiff K-File 08 25 mm (6/pk)
- 5 KontrolFlex Stiff K-File 10 25 mm (6/pk)
- 5 KontrolFlex Stiff K-File 15 25 mm (6/pk)
- 1 BC GP Assortment .04 #15-#60 (300p)
- 1 EndoSequence Lubricant (3x3g syringe)
- 1 EndoSequence BC Sealer
- 1 Canal Clean 100mL

Order No. 5027690U0

EndoSequence® Kits

EndoSequence® Access Kit



Order No. 5008861U0

K000032

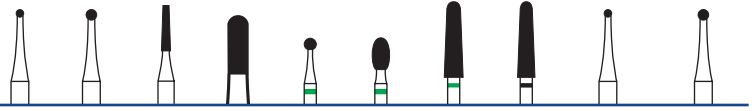

US No.	2	4	701L	-	-	-	-	-	2	4
Figure No.	H1	H1	H33L	H34L	6801	6379	6850	5850	H1	H1
Head Size (1/10 mm)	010	014	012	012	016	023	023	018	010	014
Cutting Length (mm)	1.0	1.4	6.0	3.5	1.6	4.2	10.0	10.0	1.0	1.4
Shank Type	FG	FG	FG	FG	FG	FG	FG	FG	RA SURG	RA SURG
Quantity	1	1	1	1	1	1	1	1	1	1

EndoSequence® Rotary Files Kit



File/Tip ID	Tip Size	.04 Taper			.06 Taper		
		21 mm	25 mm	31 mm	21 mm	25 mm	31 mm
Small	30-15	5009144U0	5009145U0	5009146U0	5009150U0	5009151U0	5009152U0
Medium	40-25	5009147U0	5009148U0	5009149U0	5013268U0	5013269U0	5013270U0
Large	50-35	5018144U0	5018145U0	5018146U0	5013271U0	5013272U0	5013273U0
Extra-Large	55-80	5014385U0	5014386U0	5014387U0	-	-	-



EndoSequence® .04 Trial Pack:

- 1 K000032 EndoSequence Access Kit
- 3 Expeditor 21 .04 16mm (4/pk)
- 2 Small/Extra-Small File Asst 15-30 .04 25mm (4/pk)
- 2 Medium File Asst 25-40 .04 25mm (4/pk)
- 2 Large File Asst 35-50 .04 25mm (4/pk)
- 1 Gutta Percha/Paper Points Asst Wheel .04 15-60
- 2 EndoSequence K-File Asst 8-20 .02 25mm (6/pk)
- 1 EndoSequence Chairside Guide

Order No. 5014822U0

EndoSequence® .06 Trial Pack:

- 1 K000032 EndoSequence Access Kit
- 3 Expeditor 21 .06 16mm (4/pk)
- 2 Small/Extra-Small File Asst 15-30 .06 25mm (4/pk)
- 2 Medium File Asst 25-40 .06 25mm (4/pk)
- 2 Large File Asst 35-50 .06 25mm (4/pk)
- 1 Gutta Percha/Paper Points Asst Wheel .06 15-50
- 2 EndoSequence K-File Asst 8-20 .02 25mm (6/pk)
- 1 EndoSequence Chairside Guide

Order No. 5013324U0



EndoSequence® Starter Kit:

- 1 K000032 EndoSequence Access Kit
- 5 Expedito 21 .04 16mm (4/pk)
- 5 Small/Extra-Small File Asst 15-30 .04 21mm (4/pk)
- 5 Small/Extra-Small File Asst 15-30 .04 25mm (4/pk)
- 5 Small/Extra-Small File Asst 15-30 .04 31mm (4/pk)
- 5 Medium File Asst 25-40 .04 21mm (4/pk)
- 5 Medium File Asst 25-40 .04 25mm (4/pk)
- 5 Medium File Asst 25-40 .04 31mm (4/pk)
- 5 Large File Asst 35-50 .04 21mm (4/pk)
- 5 Large File Asst 35-50 .04 25mm (4/pk)
- 5 Large File Asst 35-50 .04 31mm (4/pk)
- 5 Extra-Large File Asst 55-80 .04 21mm (4/pk)
- 5 Extra-Large File Asst 55-80 .04 25mm (4/pk)
- 5 KontrolFlex Stiff K-File 08 25mm (6/pk)
- 5 KontrolFlex Stiff K-File 10 25 (6/pk)
- 5 KontrolFlex Stiff K-File 15 25 (6/pk)
- 5 Gates Glidden Asst 50-150mm (6/pk)
- 1 BC Points/Paper Points Asst Wheel .04 15-60
- 1 EndoSequence Canal Clean (100mL)
- 1 EndoSequence Lubricant
- 1 EndoSequence BC Sealer
- 1 EndoSequence Chairside Guide

Order No. 5019354U0

EndoSequence® Complete Introductory System:

- 1 EndoSequence Case
- 1 EndoSequence 2 Handpiece
- 1 EndoSequence 2 Addition Head 10:1
- 1 K000032 EndoSequence Access Kit
- 1 K0044 Small Rotary File Kit 30-15 .04 25mm
- 1 K0047 Medium Rotary File Kit 25-40 .04 25mm
- 1 K0129 Large Rotary File Kit 35-50 .04 25mm
- 5 Expedito 21 .04 16mm (4/pk)
- 3 Small/Extra-Small File Asst 15-30 .04 25mm (4/pk)
- 6 Medium File Asst 25-40 .04 25mm (4/pk)
- 3 Large File Asst 35-50 .04 25mm (4/pk)
- 3 Extra-Large File Asst 55-80 .04 25mm (4/pk)
- 1 KontrolFlex K-File 08 25mm (6/pk)
- 1 KontrolFlex K-File 10 25 (6/pk)
- 1 KontrolFlex Stiff K-File 10 25 (6/pk)
- 1 KontrolFlex Stiff K-File 15 25 (6/pk)
- 1 KontrolFlex Stiff K-File 15 25 (6/pk)
- 1 KontrolFlex K-File 20 25 (6/pk)
- 1 BC Points/Paper Points Asst Wheel .04 15-60
- 1 EndoSequence Canal Clean (100mL)
- 1 EndoSequence BC Sealer
- 1 Curve Test Block
- 1 EndoSequence Chairside Guide

Order No. 5019355U0

EndoSequence® Kits



EndoSequence® Intro Kit:

- 2 Expeditor 21 .04 16mm (4/pk)
- 2 Small/Extra-Small File Asst 15-30 .04 25mm (4/pk)
- 3 Medium File Asst 25-40 .04 25mm (4/pk)
- 2 Large File Asst 35-50 .04 25mm (4/pk)
- 1 BC Points/Paper Points Asst Wheel .04 15-60
- 1 EndoSequence BC Sealer
- 1 K0165 EndoSequence Restorative kit
- 1 EndoSequence Chairside Guide

Order No. 5023032U0









ESX® Kits

ESX® Modern Access Kit



Order No. 5024555U0

K0284

								
US No.	1558SC	1557SC	-	-	-	-	2	4
Figure No.	H031RS	H031RS	5909	6801DC	6856DC	H269GK	H1	H1
Head Size (1/10 mm)	012	010	040	014	014	016	010	014
Cutting Length (mm)	4.0	3.9	1.0	-	8.0	9.0	RA SURG	RA SURG
Shank Type	FG	FG	FG	FG	FG	FG	1	1
Quantity	1	1	1	1	1	1		



ESX® Intro Kit:

- 5 ESX Expeditor 15 .05 25mm (3/pk)
- 2 ESX Small File 25 .04 25mm (3/pk)
- 3 ESX Medium File 35 .04 25mm (3/pk)
- 2 ESX Large File 45 .04 25mm (3/pk)
- 1 BC Points/Paper Points Asst Wheel .04 15-60
- 1 EndoSequence BC Sealer
- 1 ESX Chairside Guide

Order No. 5024346U0



K0281 ESX® Starter Kit:

- 15 ESX Expeditor 15 .05 25mm (3/pk)
- 5 ESX Small File 25 .04 25mm (3/pk)
- 10 ESX Medium File 35 .04 25mm (3/pk)
- 5 ESX Large File 45 .04 25mm (3/pk)
- 2 ESX Extra-Large File 55 .04 25mm (3/pk)
- 2 ESX Orifice Shaper 20 .08 19mm (3/pk)
- 2 ESX Scouting File 15 .02 25mm (3/pk)
- 2 ESX Scouting File 15 .04 25mm (3/pk)
- 5 KontrolFlex Stiff K-File 08 25mm (6/pk)
- 5 KontrolFlex Stiff K-File 10 25 (6/pk)
- 5 KontrolFlex Stiff K-File 15 25 (6/pk)
- 1 BC Points/Paper Points Asst Wheel .04 15-60
- 1 EndoSequence Canal Clean (100mL)
- 1 EndoSequence Lubricant
- 1 EndoSequence BC Sealer
- 1 ESX Chairside Guide

Order No. 5024347U0



K0220 BioRaCe™ Starter Kit:

- 5 KontrolFlex Stiff K-File 08 25mm (6/pk)
- 5 KontrolFlex Stiff K-File 10 25 (6/pk)
- 5 KontrolFlex Stiff K-File 15 25 (6/pk)
- 5 ScoutRaCe Asst 21mm (5/pk)
- 5 ScoutRaCe Asst 25mm (5/pk)
- 10 BR0-BR5 BioRaCe Basic Asst 21mm (6/pk)
- 5 BR4C-BR7 BioRaCe Extended Asst 21mm (4/pk)
- 10 BR0-BR5 BioRaCe Basic Asst 25mm (6/pk)
- 5 BR4C-BR7 BioRaCe Extended Asst 25mm (4/pk)
- 1 K0218 BioRaCe Access Kit
- 1 K0219 BioRaCe Chairside Block
- 1 BC Gutta Percha .04 15mm (60/pk)
- 1 BC Gutta Percha .04 35mm (60/pk)
- 1 BC Gutta Percha .04 40mm (60/pk)
- 1 BC Gutta Percha .04 50mm (60/pk)
- 1 EndoSequence BC Sealer (2g)
- 1 BioRaCe Chairside Card
- 1 ScoutRaCe Chairside Card

Order No. 5019731U0

BioRaCe™ Access Kit



Order No. 5020020U0

K0218



US No.	-	-	-	4	2
Figure No.	6850	6801	H34L	H1	H1
Head Size (1/10 mm)	023	016	012	014	010
Cutting Length (mm)	10.0	1.6	3.5	1.4	1.0
Shank Type	FG	FG	FG	FG SURG	RA SURG
Quantity	1	1	1	1	1

BioRaCe™ Chairside Procedure Block

K0219 Aluminum Block:

- Non-loaded
- Etched for Ideal BioRaCe Tray Setup

Order No. 5020021U0



Ultrasonic Tip Kit



K0209 Ultrasonic Tip Kit:

- 1 E4 Tip
- 1 E9 Tip
- 1 E9D Tip
- 1 E14D Tip
- 1 E15D Tip
- 1 A641 Black Aluminum Tip Caddy

Order No. 5019701U0

Post Kit



K0165 EndoSequence® Post Starter Kit (.04 Taper):

- 5 ea. (sizes .50-1.1) EndoSequence Posts (.04 Taper)
- 2 Double Ended Burnout Pluggers (.04 Taper)
- 1 Universal Finishing Diamond
- 1 Hand Driver
- 1 Instructions for Use (IFU)

Order No. 5015623U0

K0166 EndoSequence® Post Starter Kit (.06 Taper):

- 5 ea. (sizes .50-1.0) EndoSequence Posts (.06 Taper)
- 2 Double Ended Burnout Pluggers (.06 Taper)
- 1 Universal Finishing Diamond
- 1 Hand Driver
- 1 Instructions for Use (IFU)

Order No. 5015624U0

Aluminum Bur Blocks



A800 Aluminum Block:

Holds: 20 Small, 10 Large

Order No. 5000989U0



A812 Aluminum Block:

Holds: 48 Large

Order No. 5008130U0



A822 Aluminum Block:

Holds: 4 EndoSequence Files

Order No. 5009065U0



A803 Aluminum Block:

Holds: 15 Small, 10 Large

Order No. 5000994U0



A825 Aluminum Block:

Holds: 8 Large, 24 Small,
16 EndoSequence

Order No. 5013399U0



A641 Aluminum Block:

Holds: 6 Ultrasonic Tips

Order No. 5019698U0

Endo Solutions Caddy

Features 3 forward-angled slots for bottles, 3 large base compartments and slots to accommodate up to 12 syringes (8 x 3cc & 4 x 6cc).

Order No. 5026556U0



EndoRing® II

Organizer with Metal Ruler

- Single handed file organization
- Reduces cross contamination
- Minimizes file passing and risk of accidental puncture
- Autoclavable



EndoRing® II Kit

- 1 EndoRing® Assembly
- 12 Single-Use GelWell® Cups
- 48 e-Foam® Inserts
- 1 Metal Ruler

Order No. 5026399U0

e-Foam® Inserts (60/Pack)

Includes 30 yellow and 30 blue inserts



Order No. 5026400U0

GelWell® Cups (48/Pack)

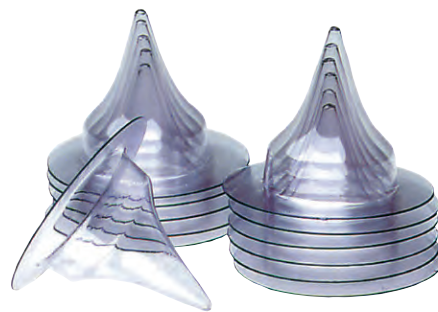

Order No. 5026401U0

EndoRing®, GelWell® and e-Foam® are registered trademarks of Jordco, Inc.

EndoSwipe™

Intra-Oral File Cleaning Sponge (25/Pack)

- Proprietary design with tangle free foam
- No need to stop the rotary file
- Individual sterile packaging



Order No. 5024743U0



DIAMONDS



CARBIDES



POLISHERS



PROCEDURE SYSTEMS



BIOCERAMICS



Since 1976, our absolute focus has been to develop products and provide services that support the practice of core operatory procedures. Today, Brasseler USA® is the premier dental instrumentation company in North America offering the most extensive selection of dental and surgical instrumentation under one brand.



HANDPIECES



ENDODONTICS



SMALL EQUIPMENT



HYGIENE



HAND INSTRUMENTS



ORAL SURGERY



LABORATORY INSTRUMENTS



Visit our website at BrasselerUSA.com

To order call 800.841.4522 or fax 888.610.1937. In Canada call 800.363.3838

